

# SAMSUNG

## ECO HEATING SYSTEM

OUTDOOR UNIT    CONTROL KIT

Model: AE090JXYDEH    MIM-E03AN  
AE090JXYDGH  
AE120JXYDEH  
AE120JXYDGH  
AE140JXYDEH  
AE140JXYDGH  
AE160JXYDEH  
AE160JXYDGH

# ***SERVICE*** Manual

### ECO HEATING SYSTEM



### CONTENTS

1. Precautions
2. Product Specifications
3. Disassembly and Reassembly
4. Troubleshooting
5. PCB Diagram
6. Wiring Diagram
7. Schematic Diagram
8. Reference Sheet

# Contents

<b>1. Precautions</b> .....	<b>3</b>
1-1 Precautions for the Service .....	3
1-2 Precautions related to static electricity and PL.....	3
1-3 Precautions for the Safety .....	4
1-4 Precautions for handling a system containing refrigerants .....	5
1-5 Precautions for the brazing .....	5
1-6 Precautions for charging refrigerants .....	5
<b>2. General Overview</b> .....	<b>6</b>
2-1 Features of the System .....	6
2-1-1 Key features of the Monobloc .....	7
2-2 Product Specifications.....	8
2-2-1 Hydro Unit .....	8
2-3 Specifications of optional items.....	10
2-3-1 Accessories.....	10
<b>3. Disassembly and Reassembly</b> .....	<b>12</b>
3-1 EHS Control Kit .....	13
3-2 Outdoor Unit.....	15
<b>4. Troubleshooting</b> .....	<b>42</b>
4-1 Check before diagnostics .....	42
4-2 OUTDOOR UNIT errors.....	44
4-2-1 Temperature sensor errors (E221,E231,E251,E320,E901,E902,E906) .....	46
4-2-2 Compressor errors (E404, E461, E467) .....	47
4-2-3 High pressure sensor protection error (E407).....	48
4-2-4 Compressor discharge error (E416) .....	49
4-2-5 EEV error (E419).....	50
4-2-6 Fan errors (E458, E475).....	51
4-2-7 Current trip errors (E462, E463, E464, E465).....	53
4-2-8 DC-link voltage under/over error (E466) .....	54
4-2-9 IPM overheating error (E500).....	55
4-2-10 Gas leakage error (E554) .....	56
4-3 CONTROL KIT & wired remote controller errors.....	57
4-3-1 EEPROM Error (E162) .....	58
4-3-2 CONTROL KIT/OUTDOOR UNIT communication error (E202).....	59
4-3-3 Communication error between INVERTER and MAIN PBA (E203) .....	60

# Contents

4-3-4 Communication tracking error(E604).....	61
4-3-5 Water outlet (backup heater) temperature sensor error (E903) .....	62
4-3-6 DHW tank temperature sensor error (E904) .....	63
4-3-7 Flow switch (ON) and water pump (OFF) error (E911) .....	64
4-3-8 Flow switch (OFF) and water pump (ON) error (E912) .....	65
4-4 Other troubleshootings .....	66
4-4-1 Heating during the cooling mode / Cooling during the heating mode .....	66
4-4-2 Initial diagnosis when the OUTDOOR UNIT is not powered on .....	68
4-4-3 OUTDOOR UNIT power supply error .....	69
<b>5. PCB Diagram .....</b>	<b>70</b>
5-1 Control Kit.....	70
5-2 Outdoor Unit.....	71
<b>6. Wiring Diagram .....</b>	<b>80</b>
6-1 Control Kit.....	80
6-2 Outdoor Unit.....	81
<b>7. Reference Sheet .....</b>	<b>83</b>
7-1 Index for Model Name.....	83
7-1-1 Outdoor Unit .....	83
7-2 Refrigerant Circuit Diagram .....	84

---

# 1. Precautions

---

## 1-1 Precautions for the Service

---

- **Use the standard parts when replacing the electric parts.**
  - Confirm the model name, rated voltage, rated current of the electric parts.
- **When repairing the equipment, connection of the harness parts must be firm and solid.**
  - A loose connection may cause noise or other malfunction.
- **When assembling and disassembling the equipment while it is laid down, lay it on soft cloth.**
  - Otherwise it may scratch the back of the exterior of the product.
- **Remove dust or dirt completely from the housing block, wiring block and service parts during repair.**
  - This helps prevent the danger of fire caused by tracking or short circuit.
- **Fasten the valve caps of service valves and charging valves of outdoor unit as much as possible using adjustable wrenches.**
- **Check the status of the components' assembly after repair service.**
  - The status must be the same as before the repair service.

## 1-2 Precautions related to static electricity and PL

---

- **The PCB power supply block is susceptible to static electricity. Therefore, care must be taken during repair or measuring while the power is on.**
  - Wear insulation gloves for PCB repair or measuring.
- **Check whether the installation location is at least two meters away from other electronic products such as TV, video, or audio.**
  - Otherwise, the video quality might be degraded or noise might be generated.
- **Do not let end users repair the products themselves.**
  - Unauthorized disassembly might cause electric shock or fire.

## 1-3 Precautions for the Safety

---

- **Do not pull any electric wires and do not touch an auxiliary power switch with a wet hand.**
  - There is a danger of electric shock or fire.
- **In case any wire or power plug has been damaged, replace it to eliminate any possible danger.**
- **Do not bend the power cord by force and do not put any heavy object on the power cord.**
  - There is a danger of electric shock or fire.
- **Do not use multi socket.**
  - There is a danger of electric shock or fire.
- **Ground the product if necessary.**
  - Be sure to ground the product if there is any danger of electric leakage due to water or moisture.
- **Be sure to turn off the auxiliary power switch or pull out the power plug during replacement or repair of electric parts.**
  - There is a danger of electric shock.
- **In case the product will not be in use for a long time, the battery of remote control should be kept separately.**
  - Leakage of inside fluid can cause break down of remote control.
- **The installation must be done by the manufacturer or its service agent or a similar qualified person in order to avoid a hazard.**
  - Installation by an unqualified person may cause a water leakage, electric shock or fire and so on.
- **The electric work must be done by service agent or similarly qualified persons according to national wiring regulations and use only rated cable.**
  - If the capacity of the power cable is insufficient or electric work is not properly completed, electric shock or fire may occur.
- **Use only rated parts and tools.**
  - If you don't use the rated parts and tools, it can cause trouble with the air conditioner and bring about injury.
- **If any gas or impurities except R410A refrigerant come into the refrigerant pipe, serious problem may occur and it may cause injury.**
- **Leak test must be done using only Nitrogen(NO<sub>2</sub>)gas.**

- R410A refrigerant is used for EHS.
  - When using R410A, moisture or foreign substances may affect to the capacity and reliability of the product. Safety precautions must be taken when installing the refrigerant pipe.
  - The design pressure of the unit is 4.1MPa. Select appropriate material and thickness according to the regulations.
  - R410A is a quasi-azeotrope of two refrigerants.  
Make sure to charge liquid one when adding refrigerant.  
If you charge gaseous refrigerant, it may affect the capacity and reliability of the product as a result of change formation of the refrigerant.

## 1-4 Precautions for handling a system containing refrigerants

---

All system containing refrigerants shall be removed under regional regulations prior to the disposal to prevent the potential health and environmental consequences.

- **Harmful for human body**
  - When emitted liquid refrigerant contacts human body, contacted area may get frostbite, blister or become numb.
  - If refrigerant leaks in airtight area, lack of oxygen may cause suffocation. When refrigerant is heated, it may generate harmful gas.
- **Precautions for handling container**
  - Do not apply shock or heat to the refrigerant container.

## 1-5 Precautions for the brazing

---

- **Clear any dangerous or inflammable materials in surrounding environment.**
- **Make sure to empty the remaining refrigerant in the product or pipe before brazing.**
  - Brazing with the refrigerant still remaining in the product or pipe may cause poor result and generate harmful gas. Furthermore, pressure of the refrigerant may increase and cause damage to the leaking part. This may lead harmful refrigerant and oil to spurt out which can be dangerous for service personnel.
- **Use nitrogen gas to get rid of the oxide forming during brazing.**
  - Using other type of gas may cause damage to the product or the exterior.

## 1-6 Precautions for charging refrigerants

---

- **Add quantity of the refrigerant using a scale and perform a test operation with S-net.**
  - Product performance may decrease if you add excessive amount of refrigerant.
- **Do not charge refrigerants while heating the container up.**
  - The container may get damaged by the heat and result in explosions.
- **Do not operate the product without pressure switch(for product protection) and sensor.**
  - If there are any internal blockage, high refrigerant pressure increase may damage the product or exterior.

## 2. General Overview

### 2-1 Features of the System

#### POWER SAVING

**EHS(Eco Heating System)** considers the trend in air conditioner use. It optimizes the energy efficiency of loads ranging from partial to full. It achieves an excellent energy effect for the users of the air conditioner.

#### Samsung patented compressor

Samsung has been researching and developing compressors since the 70's. It has developed power saving compressors for more than thirty years.

The **EHS(Eco Heating System)** compressor adopts a double-rotor BLDC compressor with permanent magnets made by Samsung. Electricity for the compressor rotor is obtained from a neodymium-iron-boron permanent magnetic material (boron magnet can attract iron material weighing 1000 times its own weight.) It strengthens the rotary moment of the compressor to maximize the entire efficiency of the compressor.

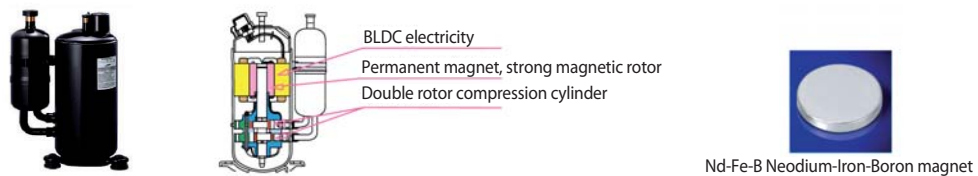

**SAMSUNG's** double-rotor compressor has the upper and lower rotors designed symmetrically. The double rotor in symmetry can remove vibrations caused by the eccentric design of the cylinder.

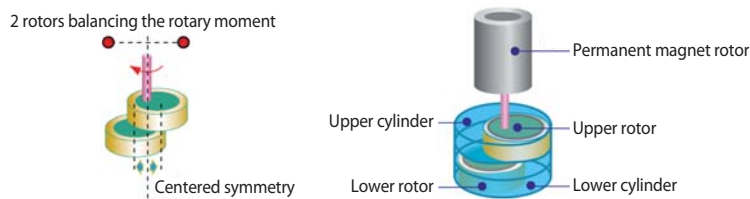

#### High efficiency heat exchanger

**EHS(Eco Heating System)** uses new multiple-teeth screw pipes with a diameter of 8 mm to improve the heat exchangeability of the pipe by **30.8%**.

The water-friendly aluminum foil in the heat exchanger uses the G-fin patent design to improve the efficiency of heat exchange by **13%**.



#### DC fan electricity

The **EHS(Eco Heating System)** outdoor machine uses DC fan electricity. The rotational speed of electricity is 100 RPM to 1050 RPM with step-free control. The electrical efficiency is improved by about **33%** compared to AC electricity.

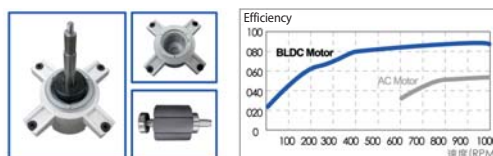

## 2-1-1 Key features of the Monobloc

### ■ Easy installation

No need to install the refrigerant lines in the system. Users can run the system after connecting water pipes only.

### ■ Integrated Heating & Cooling system

Plate Heat exchanger is an integral part in heating & cooling system. For user's convenience, PHE is integrated into the system. This concept will help space saving and lower costs for pipe line reduction.

### ■ Running Costs-Reduction of Up to 32.4%

Samsung EHS, known for its world class efficiency (12kW floor heating system with COP of 4.51), can reduce 32.4% of your running costs as compared to a gas boiler.



### ■ High Performance at Low Temperature

Samsung EHS is made up of an inverter compressor optimally operated according to the outdoor temperature, offering heating performance of 90% at -10°C and reliable frost protection at -25°C.



## 2-2 Product Specifications

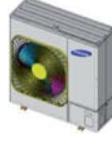



### 2-2-1 Hydro Unit

Item				AE160JXYDGH	AE140JXYDGH	AE120JXYDGH	AE090JXYDGH
				3phase 16kW	3phase 14kW	3phase 12kW	3phase 9kW
Image	Outdoor unit						
	Control Kit						
	Remote Controller						
A2W Condition #1. (A7/W35) *1	Nominal Capacity	Heating	W	9,000	12,000	14,000	16,000
			Btu/h	30,700	40,900	47,800	54,600
		Cooling	W	7,000	12,000	13,000	14,000
			Btu/h	23,900	40,900	44,300	47,800
	Power Input (Nominal)	Heating	W	2,140	2,660	3,140	3,800
		Cooling	W	1,920	3,160	3,500	3,840
	Current Input (Nominal)	Heating	A	3.5	4.2	4.8	5.7
		Cooling	A	3.2	5.2	5.3	5.8
COP (Nominal Heating)			W/W	4.21	4.51	4.46	4.21
EER (Nominal Cooling)			W/W	3.65	3.80	3.71	3.65
A2/W35	Capacity	Heating	W	7,700	9,800	11,200	12,500
	COP		W/W	3.26	3.32	3.26	3.10
A-7/W35	Capacity	Heating	W	7,600	10,300	10,800	13,400
	COP		W/W	2.39	2.61	2.56	2.47
Field Wiring	MCA	A	10	10	12	12	
	MFA	A	16.1	16.1	16.1	16.1	
	Power Source Wire	m <sup>2</sup>	1.5↑	1.5↑	1.5↑	1.5↑	
	Transmission Cable	m <sup>2</sup>	0.75↑	0.75↑	0.75↑	0.75↑	
Water Connections	Water Flow Rate (Heating/Cooling)		LPM	26/21	35/35	40/37	46/40
	Water Pressure (Max)		bar	3	3	3	3
	Water Pipe	Inlet	Φ, inch	BSPP male 1"	BSPP male 1"	BSPP male 1"	BSPP male 1"
		Outlet	Φ, inch	BSPP male 1"	BSPP male 1"	BSPP male 1"	BSPP male 1"
	Leaving Water Temperature	Heating	°C	25~55	25~55	25~55	25~55
Cooling		°C	5~25	5~25	5~25	5~25	
Refrigerant	Type		-	R410A	R410A	R410A	R410A
	Control Method		-	EEV	EEV	EEV	EEV
	Factory Charging		g	1,500	2,600	2,600	2,600
Power Supply			Φ, #, V, Hz	G(380~415V, 50Hz, 3Φ)	G(380~415V, 50Hz, 3Φ)	G(380~415V, 50Hz, 3Φ)	G(380~415V, 50Hz, 3Φ)
Sound *3	Sound Pressure	Heating Std High	dB(A)	48	50	51	52
		Cooling Std High	dB(A)	48	50	52	54
	Sound Power	Heating Std High	dB	63	64	65	66
External Dimension	Net Weight		kg	76.0	108.0	108.0	108.0
	Shipping Weight		kg	84.0	118.0	118.0	118.0
	Net Dimensions (WxHxD)		mm	940 x 998 x 330	940 x 1,420 x 330	940 x 1,420 x 330	940 x 1,420 x 330
	Shipping Dimensions (WxHxD)		mm	995 x 1,178 x 426	995 x 1,598 x 426	995 x 1,598 x 426	995 x 1,598 x 426
Operating Temp. Range	A2W	Heating	°C	-25~35	-25~35	-25~35	-25~35
		Cooling	°C	10~46	10~46	10~46	10~46
		D.Hot Water	°C	-25~43	-25~43	-25~43	-25~43

\*1) A2W Condition #1 : (Heating) Water In/Out 30°C/35°C, Outdoor Air 7°C DB/6°C WB; (Cooling) Water In/Out 23°C/18°C, Outdoor Air 35°C DB.

\*2) Sound pressure was acquired in an anechoic room. Thus actual noise level may be different depending on the installation conditions.

## Product Specifications (cont.)

Item			AE160JXYDEH		AE140JXYDEH		AE120JXYDEH		AE090JXYDEH	
			1phase 16kW		1phase 14kW		1phase 12kW		1phase 9kW	
Image	Outdoor unit									
	Control Kit									
	Remote Controller									
A2W Condition #1. (A7/W35) *1	Nominal Capacity	Heating	W	9,000	12,000	14,000	16,000			
			Btu/h	30,700	40,900	47,800	54,600			
	Cooling	W	7,500	12,000	13,000	14,000				
		Btu/h	25,600	40,900	44,300	47,800				
	Power Input (Nominal)	Heating	W	2,140	2,660	3,140	3,800			
			Cooling	1,950	3,160	3,500	3,840			
	Current Input (Nominal)	Heating	W	9.2	12	14.3	17.1			
Cooling			A	9	14.3	15.7	17.3			
COP (Nominal Heating)		W/W	4.21	4.51	4.46	4.21				
EER (Nominal Cooling)		W/W	3.85	3.80	3.71	3.65				
A2/W35	Capacity	Heating	W	7,700	9,800	11,200	12,500			
			COP	W/W	3.26	3.32	3.26	3.10		
A-7/W35	Capacity	Heating	W	7,600	10,300	10,800	13,400			
			COP	W/W	2.39	2.61	2.56	2.47		
Field Wiring	MCA		A	22	28	30	32			
	MFA		A	27.5	35	37.5	40			
	Power Source Wire		m'	4.0↑	6.0↑	6.0↑	6.0↑			
	Transmission Cable		m'	0.75↑	0.75↑	0.75↑	0.75↑			
Water Connections	Water Flow Rate (Heating/Cooling)		LPM	26/22	35/35	40/37	46/40			
	Water Pressure (Max)		bar	3	3	3	3			
	Water Pipe	Inlet	Φ, inch	BSPP male 1"	BSPP male 1"	BSPP male 1"	BSPP male 1"			
		Outlet	Φ, inch	BSPP male 1"	BSPP male 1"	BSPP male 1"	BSPP male 1"			
	Leaving Water Temperature	Heating	°C	25~55	25~55	25~55	25~55			
			Cooling	°C	5~25	5~25	5~25	5~25		
Refrigerant	Type		-	R410A	R410A	R410A	R410A			
	Control Method		-	EEV	EEV	EEV	EEV			
	Factory Charging		g	1,400	2,600	2,600	2,600			
Power Supply			Φ, #, V, Hz	E(220~240V, 50Hz, 1Φ)	E(220~240V, 50Hz, 1Φ)	E(220~240V, 50Hz, 1Φ)	E(220~240V, 50Hz, 1Φ)			
Sound *3	Sound Pressure	Heating Std High	dB(A)	48	50	51	52			
		Cooling Std High	dB(A)	48	50	52	54			
	Sound Power	Heating Std High	dB	63	64	65	66			
External Dimension	Net Weight		kg	76.0	108.0	108.0	108.0			
	Shipping Weight		kg	84.0	118.0	118.0	118.0			
	Net Dimensions (WxHxD)		mm	940 x 998 x 330	940 x 1,420 x 330	940 x 1,420 x 330	940 x 1,420 x 330			
	Shipping Dimensions (WxHxD)		mm	995 x 1,178 x 426	995 x 1,598 x 426	995 x 1,598 x 426	995 x 1,598 x 426			
Operating Temp. Range	A2W	Heating	°C	-25~35	-25~35	-25~35	-25~35			
		Cooling	°C	10~46	10~46	10~46	10~46			
		D.Hot Water	°C	-25~43	-25~43	-25~43	-25~43			

\*1) A2W Condition #1 : (Heating) Water In/Out 30°C/35°C, Outdoor Air 7°C DB/6°C WB; (Cooling) Water In/Out 23°C/18°C, Outdoor Air 35°C DB.





\*2) Sound pressure was acquired in an anechoic room. Thus actual noise level may be different depending on the installation conditions.

## 2-3 Specifications of optional items

### 2-3-1 Accessories



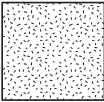





Item	Description	Code No.	Q'ty	Remark
	Cap Drain	DB63-10355C	5	Essential Offer (Outdoor Unit)
	Drain Plug	DB67-00806A	2	
	Rubber Leg	DB73-20134A	4	
	MANUAL INSTALL (Outdoor Unit)	DB68-05387A	1	
	MANUAL USERS (CONTROL KIT)	DB68-05402A	1	Essential Offer (Control Kit)
	MANUAL INSTALL (CONTROL KIT)	DB68-05388A	1	
	Switch-Flow	DB34-00079A	1	
	Wired remote controller	DB93-11251L	1	
	Connector Wire (Smart Grid, 2000mm)	DB93-13255A	1	
	SENSOR TEMP	DB32-00213A	1	
	Thermistor (Water Tank)	DB95-05023A	1	
	SENSOR TEMP	DB32-00217A	1	
	HOLDER SENSOR	DB61-05217A	2	
	SPRING ETC-SENSOR	DB81-00635A	2	
	CABLE TIE	DB65-10088C	4	

## Accessories

Item	Description	Code No.	Q'ty	Remark
	TAPE-HANDLE CABI SIDE	DB74-00039D	2	Essential Offer (Control Kit)
	RUBBER-PIPE	DB73-00436B	2	
	INSULATION-BASE	DB72-00401F	2	
	ASSY CONNECTOR WIRE-CLIP (Back-up heater connector(Brown))	DB93-08924R	1	
	LEAD CONNECTOR (Back-up heater connector (Red))	DB39-00941A	1	
	LEAD CONNECTOR (Back-up heater connector(White))	DB39-00941B	1	

### 3. Disassembly and Reassembly

#### ■ Hand Tool sets

Item	Remark
+Screw Driver	
Adjustable wrench	
-Screw Driver	
Nipper	
Electric Motion Driver	
L-Wrench	
Torque Lench	
Latchet Lench	

### 3-1 EHS Control Kit

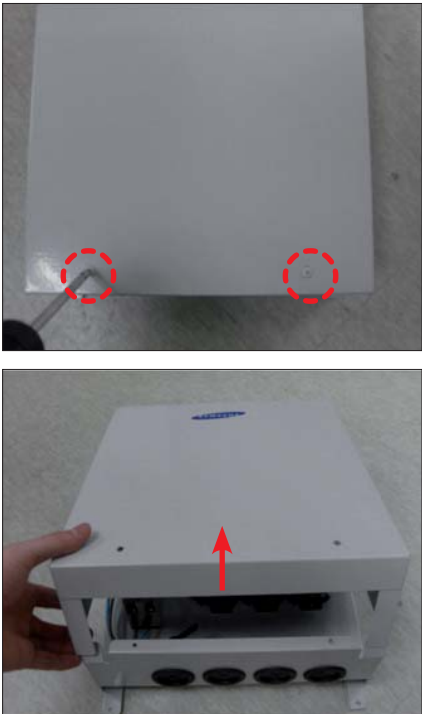
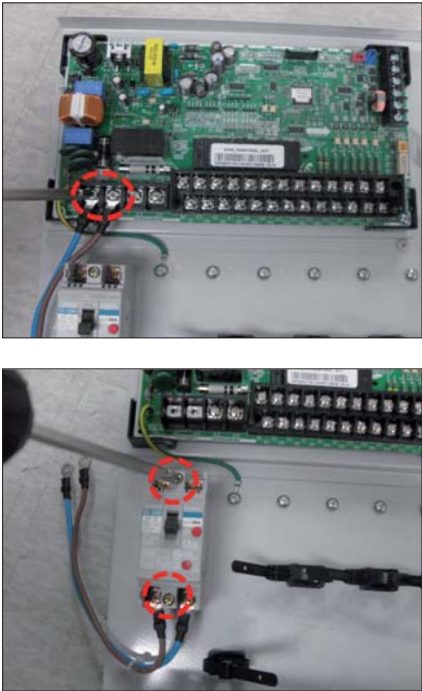

Be sure that the power switch is in the OFF and the power source cord shall be unplugged prior to disassembly and reassembly works.

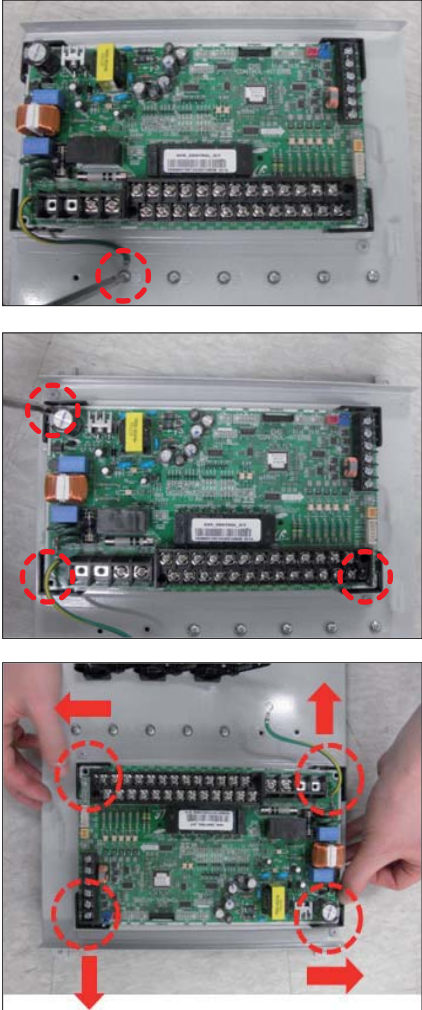
No	Parts	Procedure	Remark
1	CABINET TOP	<p><b>⚠ You must turn off the power before disassembling.</b></p> <p>1) Unscrew and remove the two screws on the CABINET TOP. (Use '+' type screw driver)</p> <p>2) Remove the CABINET TOP.</p>	
2	ELCB	<p>1) Unscrew and remove the two screws of the power supply cable on the terminal block. (Use '+' type screw driver)</p> <p>2) Unscrew and remove the two screws on the top &amp; bottom of the ELCB. (Use '+' type screw driver)</p>	

No	Parts	Procedure	Remark
3	ASSY PCB MAIN OUT	<p>1) Unscrew and remove the earth screw on the CABINET BOTTOM. (Use '+' type screw driver)</p> <p>2) Unscrew and remove the three screws (Use '+' type screw driver)</p> <p>3) Pull the PCB support to each direction.</p> <p><b>⚠ Please note that PCB support may be broken by your excessive pulling.</b></p>	

## 3-2 Outdoor Unit

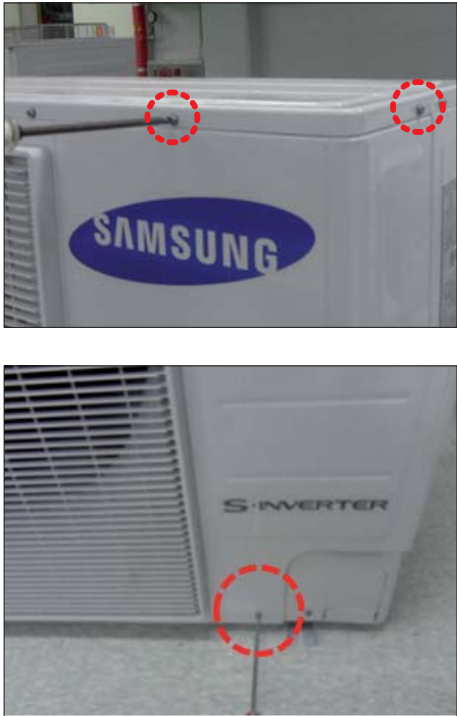

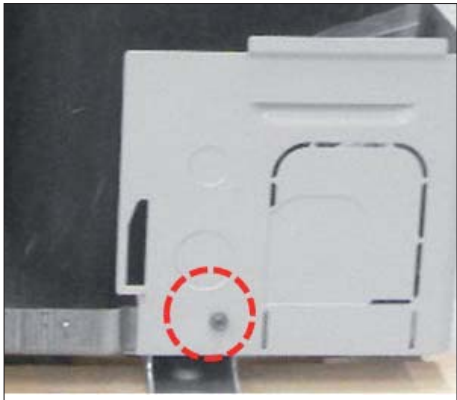
### ■ AE160JXYD\*/AE140JXYD\*/AE120JXYD\*

No	Parts	Procedure	Remark
1	CABI FRONT RH	<p><b>⚠ You must turn off the power before disassembling.</b></p> <p>1) Unscrew and remove the three screws on the CABI FRONT RH. (Use '+' type screw driver)</p>	
2	CABI TOP	<p>1) Unscrew and remove the nine screws on each side of the CABI TOP. (Use '+' type screw driver)</p>	
3	CABI INSTALL FRONT	<p>1) Unscrew and remove the screw on the CABI INSTALL FRONT. (Use '+' type screw driver)</p>	

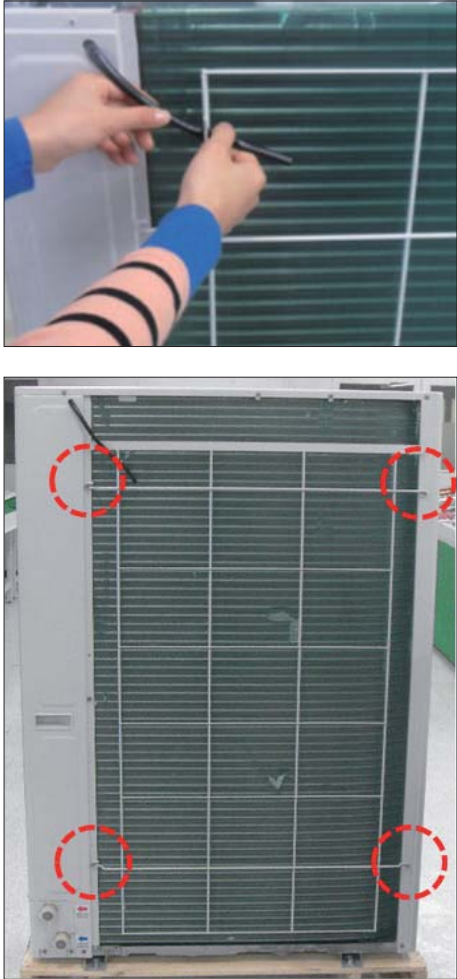

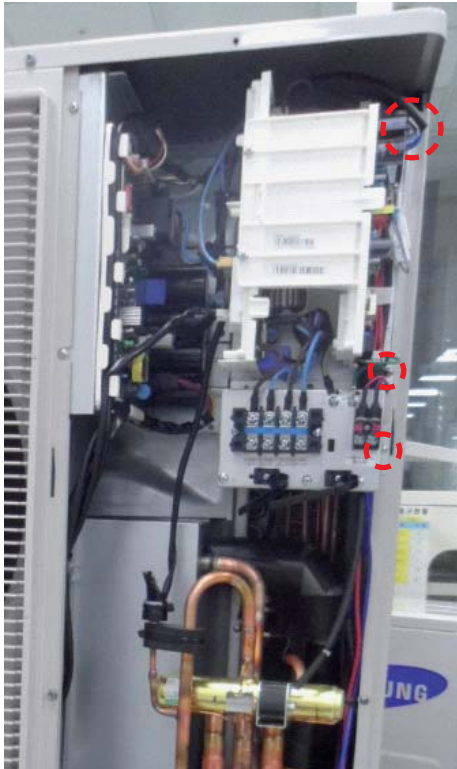

No	Parts	Procedure	Remark
4	GUARD COND	<p>1) Pull the sensor from Guard Cond.</p> <p>2) Unscrew and remove the four screws on the GUARD COND. (Use '+' type screw driver)</p>	 <p>The top photograph shows a person's hands using a screwdriver to pull a sensor from the guard condenser. The bottom photograph shows the guard condenser with four screws circled in red, indicating the locations to be unscrewed.</p>



No	Parts	Procedure	Remark
5	CABI BACK RH	<p>1) Pull the sensor from the CABI BACK RH.</p> <p>2) Unscrew and remove the nine screws on each side the CABI BACK RH. (Use '+' type screw driver)</p>	  

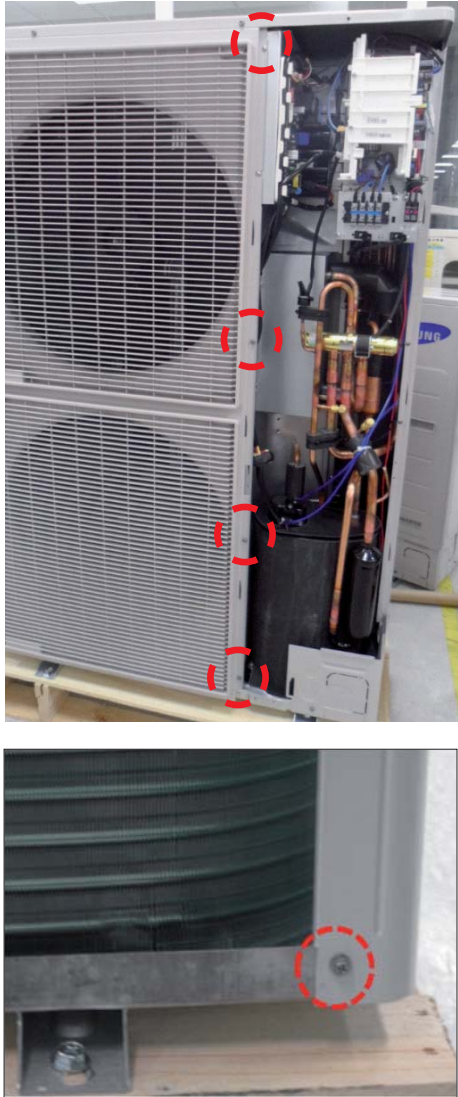

No	Parts	Procedure	Remark
			
6	CABI INSTALL BACK	<p>1) Unscrew and remove the 7 screws in the Cabinet-Install Back. (Use '+' type screw driver)</p>	

No	Parts	Procedure	Remark
7	CABI FRONT LF	1) Unscrew and remove 10 screws. in the Cabinet-Front LF. (Use '+' type screw driver)	

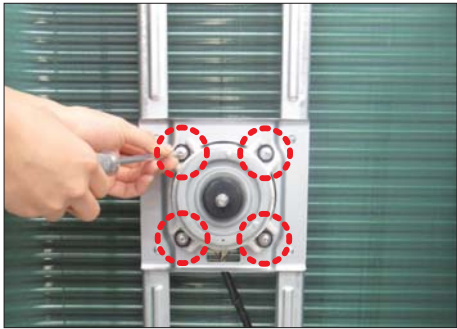
No	Parts	Procedure	Remark
			

No	Parts	Procedure	Remark
8	FAN	1) Turn the two nuts as shown in the picture and remove them. (Use adjustable wrench)	

No	Parts	Procedure	Remark
9	MOTOR	<p>1) Remove the fan.</p> <p>2) Unscrew and remove the eight motor screws. (Use '+' type screw driver)</p> <p>3) Disconnect the motor wire from the Ass'y Control Out.</p>	 

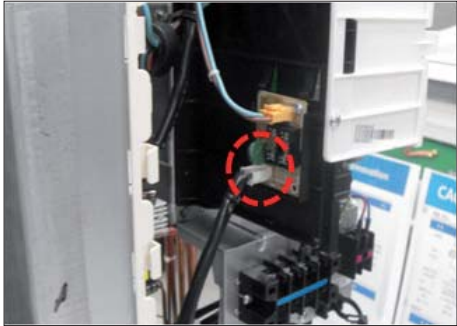
No	Parts	Procedure	Remark
10	BRACKET MOTOR	1) Unscrew and remove the two screws on the BRACKET MOTOR. (Use '+' type screw driver)	
11	HEATER	1) Unscrew and remove the three screws on the BRACKET MOTOR. (Use '+' type screw driver)  2) Disconnect the heater wire from the ASSY CONTROL OUT.	 



No	Parts	Procedure	Remark
12	CONTROL OUT	<p>1) Disconnect the six connectors from the ASSY CONTROL OUT</p> <p>2) Unscrew and remove the two mounting screws on the CONTROL OUT. (Use '+' type screw driver)</p> <p>3) Separate the ASSY CONTROL OUT.</p>	

No	Parts	Procedure	Remark
13	ASSY 4WAY VALVE	<p>1) Purge the coolant first.</p> <p>2) Separate the pipe from the Entrance/Exit using a welder.</p> <p><b>⚠</b> When removing the compressor, heat exchanger and pipe, purge the completely and remove the pipe with a welding flame.</p>	

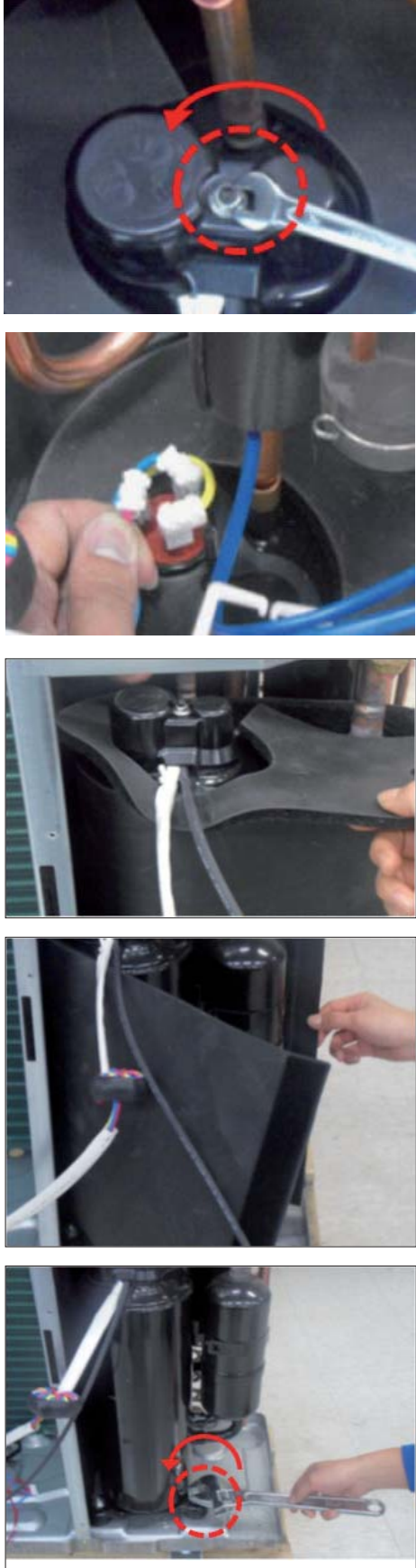

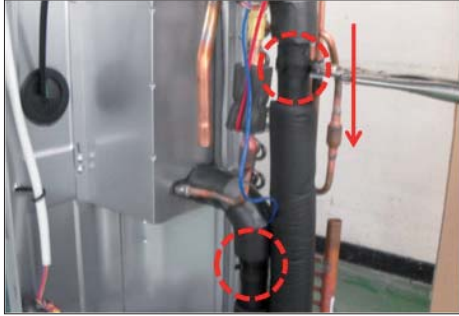
No	Parts	Procedure	Remark
14	COMPRESSOR	<p>1) Unscrew and remove the nut on the COVER TERMINAL. (Use adjustable wrench)</p> <p>2) Separate the compressor wire.</p> <p>3) Separate the COMPRESSOR FELT SOUND.</p> <p>4) As shown in the picture, unscrew and remove 3 mounting screws from the bottom. (Use Adjustable Wrench)</p>	

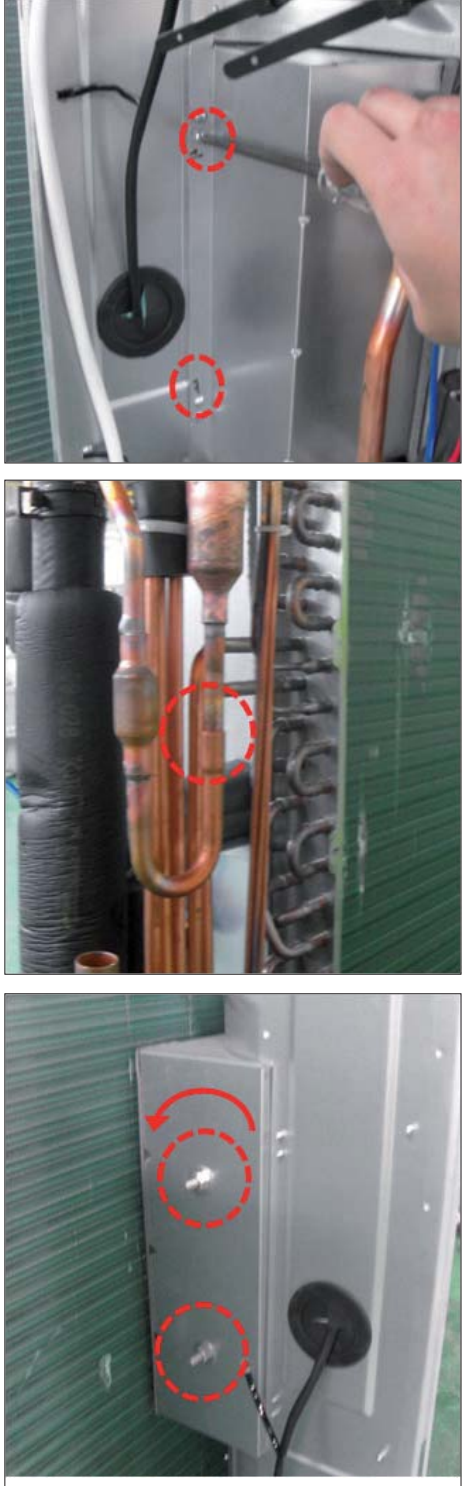
No	Parts	Procedure	Remark
15	ASS'Y WATER TUBE IN/OUT	1) Separate the Hose from the Water tube using a pleyer.	

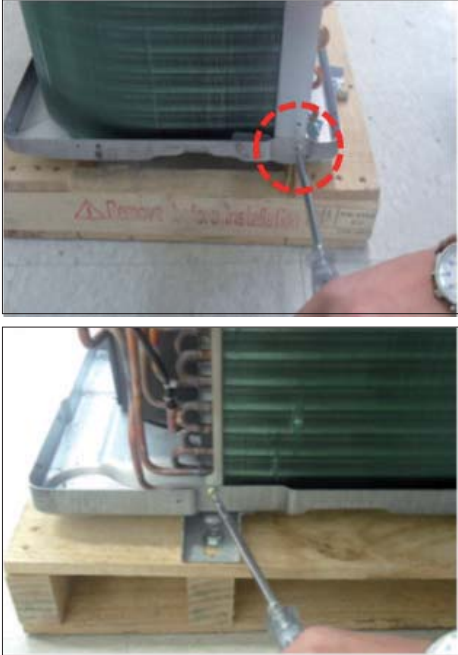
No	Parts	Procedure	Remark
16	ASSY PHE	<p>1) Unscrew and remove 2 screws in Partition. (Use '+' type screw driver)</p> <p>2) Separate the Bracket PHE Top.</p> <p>3) Separate the pipe from the Entrance/Exit using a welder.</p> <p>4) As shown in the picture, unscrew and remove 2 mounting screws from the partition. (Use Adjustable Wrench)</p>	

No	Parts	Procedure	Remark
17	ASSY COND OUT	1) Unscrew and remove 2 screws on each side of the Assy Cond Out. (Use '+' type screw driver)	

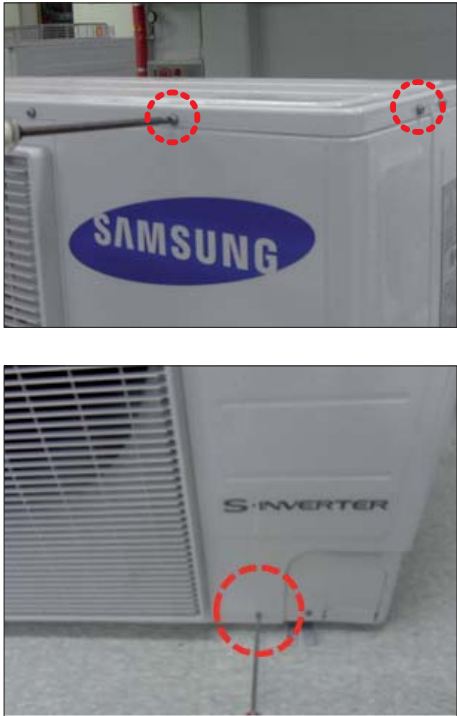
■ AE090JXYD\*

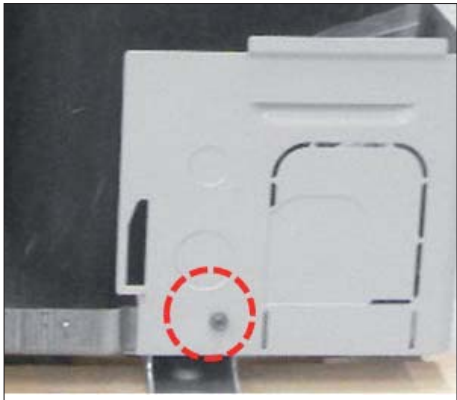
No	Parts	Procedure	Remark
1	CABI FRONT RH	<p><b>⚠ You must turn off the power before disassembling.</b></p> <p>1) Unscrew and remove the three screws on the CABI FRONT RH. (Use '+' type screw driver)</p>	
2	CABI TOP	<p>1) Unscrew and remove the nine screws on each side of the CABI TOP. (Use '+' type screw driver)</p>	
3	CABI INSTALL FRONT	<p>1) Unscrew and remove the screw on the CABI INSTALL FRONT. (Use '+' type screw driver)</p>	

No	Parts	Procedure	Remark
4	GUARD COND	<p>1) Pull the sensor from Guard Cond.</p> <p>2) Unscrew and remove the four screws on the GUARD COND. (Use '+' type screw driver)</p>	 





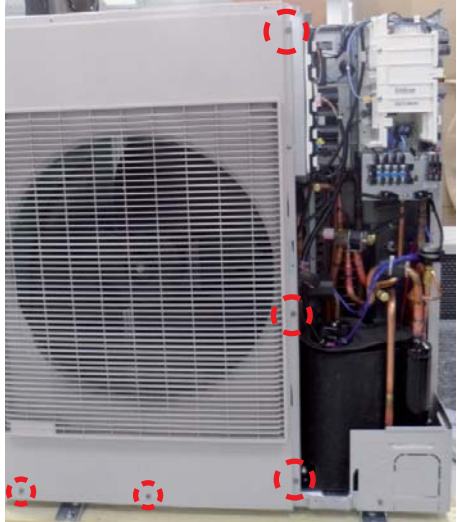

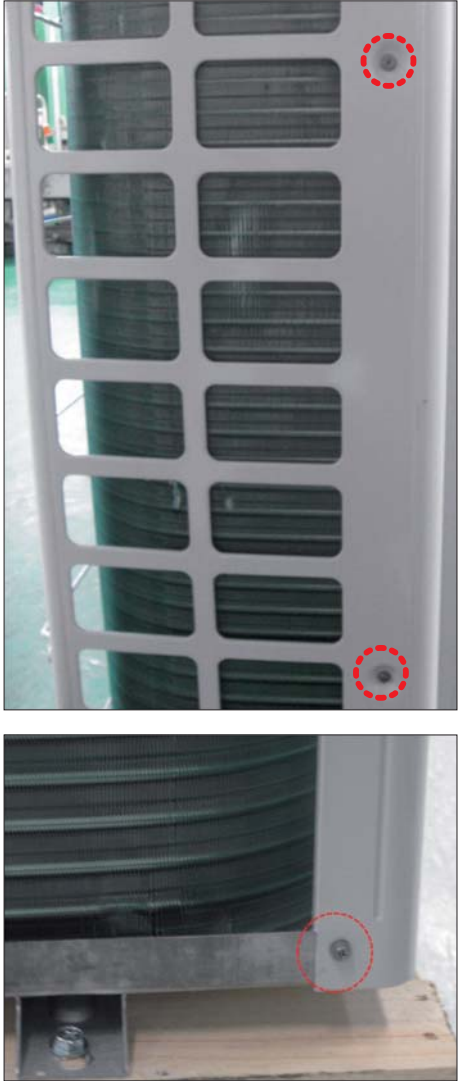
No	Parts	Procedure	Remark
5	CABI BACK RH	<p>1) Pull the sensor from the CABI BACK RH.</p> <p>2) Unscrew and remove the nine screws on each side the CABI BACK RH. (Use '+' type screw driver)</p>	  

No	Parts	Procedure	Remark
			
6	CABI INSTALL BACK	1) Unscrew and remove the 8 screws on the CABI FRONT LF. (Use '+' type screw driver)	

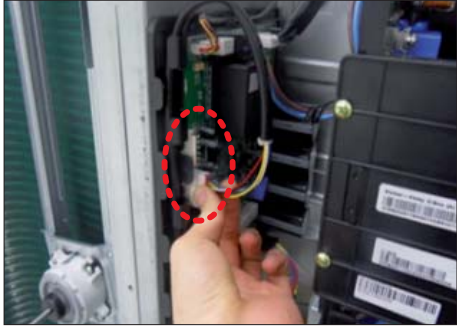
No	Parts	Procedure	Remark
			

No	Parts	Procedure	Remark
7	FAN	1) Turn the two nuts as shown in the picture and remove them. (Use adjustable wrench)	

No	Parts	Procedure	Remark
8	MOTOR	<p>1) Remove the fan.</p> <p>2) Unscrew and remove the eight motor screws. (Use '+' type screw driver)</p> <p>3) Disconnect the motor wire from the Ass'y Control Out.</p>	 

No	Parts	Procedure	Remark
9	BRACKET MOTOR	1) Unscrew and remove the two screws on the BRACKET MOTOR. (Use '+' type screw driver)	
10	HEATER	1) Unscrew and remove the three screws on the BRACKET MOTOR. (Use '+' type screw driver)  2) Disconnect the heater wire from the ASSY CONTROL OUT.	 

No	Parts	Procedure	Remark
11	CONTROL OUT	<p>1) Disconnect the six connectors from the ASSY CONTROL OUT</p> <p>2) Unscrew and remove the three screws on the CONTROL OUT. (Use '+' type screw driver)</p> <p>3) Separate the ASSY CONTROL OUT.</p>	

No	Parts	Procedure	Remark
12	ASSY 4WAY VALVE	<p>1) Purge the coolant first.</p> <p>2) Separate the pipe from the Entrance/Exit using a welder.</p> <p><b>⚠ When removing the compressor, heat exchanger and pipe, purge the completely and remove the pipe with a welding flame.</b></p>	

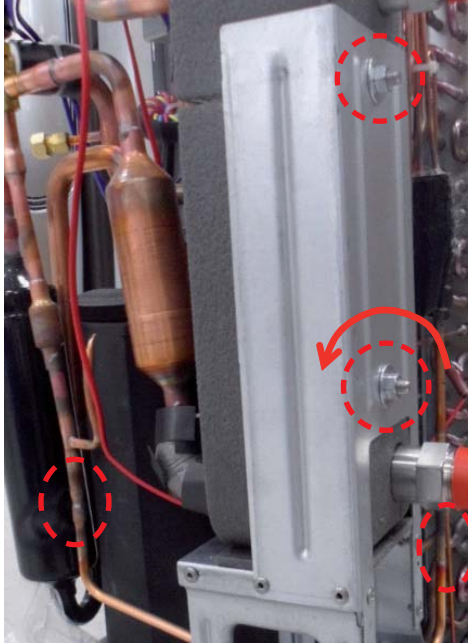
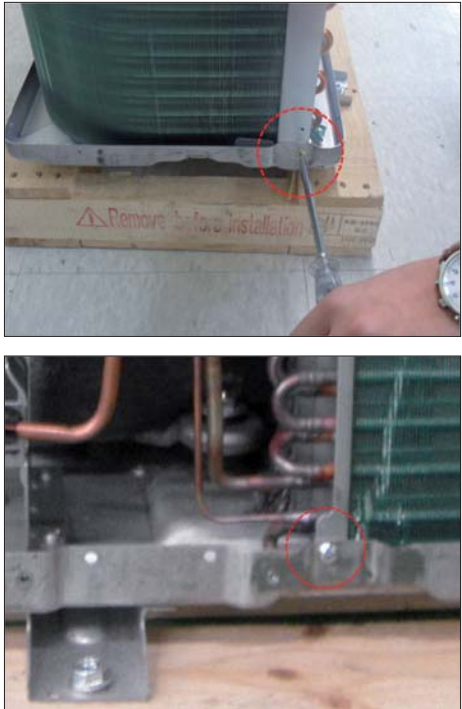

No	Parts	Procedure	Remark
13	COMPRESSOR	<p>1) Unscrew and remove the nut on the COVER TERMINAL. (Use adjustable wrench)</p> <p>2) Separate the compressor wire.</p> <p>3) Separate the COMPRESSOR FELT SOUND.</p> <p>4) As shown in the picture, unscrew and bottom. (Use Adjustable Wrench)</p>	

No	Parts	Procedure	Remark
14	ASSY PHE	1) Separate the pipe from the Entrance/Exit using a welder. 2) As shown in the picture, unscrew and remove the two screws from the BRACKET PHE. (Use adjustable wrench)	
15	ASSY COND OUT	1) Unscrew remove the two screws on each side of the ASSY COND OUT. (Use '+' type screw driver)	

## 4. Troubleshooting

### 4-1 Check before diagnostics

#### Test operation mode

KEY	KEY operation	7-segment display
K1	Press once : Heating test run	"F" "7" "BLANK" "BLANK"
	Press twice : Defrost test run	"F" "3" "BLANK" "BLANK"
	Press 3times : Finishing test mode	-
K2	Press once : Cooling test run (Heating Only : skip)	"F" "2" "BLANK" "BLANK"
	Press twice : Output signal test run	"F" "4" "BLANK" "BLANK"
	Press 3 times : Finishing test mode	-
K3	Reset	-
K4	View mode	Refer to View mode display

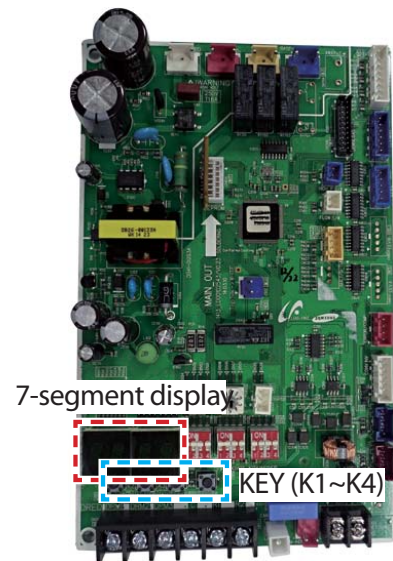

#### VIEW mode display

Number of press	Display contents	Display				Units
		Segment 1	Segment 2	Segment 3	Segment 4	
0	Communication State	10s digit of Tx	1s digit of Tx	10s digit of Rx	1s digit of Rx	-
1	Order frequency	1	100s digit	10s digit	1s digit	Hz
2	Current frequency	2	100s digit	10s digit	1s digit	Hz
3	Pump output	3	100s digit	10s digit	1s digit	%
4	Outdoor air sensor	4	+/-	10s digit	1s digit	°C
5	Discharge sensor	5	100s digit	10s digit	1s digit	°C
6	Eva in sensor	6	+/-	10s digit	1s digit	°C
7	Inlet water sensor	7	+/-	10s digit	1s digit	°C
8	Outlet water sensor	8	+/-	10s digit	1s digit	°C
9	Cond sensor	9	+/-	10s digit	1s digit	°C
10	Current	A	10s digit	1s digit	First decimal	A
11	Fan RPM	B	1000s digit	100s digit	10s digit	rpm
12	Target discharge temperature	C	100s digit	10s digit	1s digit	°C
13	EEV	D	1000s digit	100s digit	10s digit	step
14	Protective control	E	0 : Cooling 1 : Heating	Protective control 0 : No protective control 1 : Freezing 2 : Defrosting 3 : Over-load 4 : Discharge 5 : Total current	Frequency status 0 : Normal 1 : Hold 2 : Down 3 : Up_limit 4 : Down_limit	-
15	IPM temp.	F	+/-	10s digit	1s digit	°C
long-1	Main Micom version	Year(Dec)	Month(Hex)	Day(two digit)	Day(One digit)	-
long-1 and 1	Inverter Micom version	Year(Hex)	Month(Hex)	Day(two digit)	Day(One digit)	-
long-1 and 2	EEPROM version	Year(Hex)	Month(Hex)	Day(two digit)	Day(One digit)	-

■ **DIP Switch Settings**

	<b>ON (default)</b>	<b>OFF</b>	<b>Remark</b>
K5	Heat Pump.	Heating Only.	
K6	Anti-stack snow mode OFF.	Anti-stack snow mode ON.	
K97	Silence operation		
	K7	K8	
K8	ON	ON	Silence mode Step 1
	ON	OFF	Silence mode Step 2
	OFF	ON	Silence mode Step 3
	OFF	OFF	Silence mode Step 1

## 4-2 OUTDOOR UNIT errors

Error No.	Contents	Measure	LED Display		
			Red	Green	Yellow
E201	Hydro Unit quantity is mismatched.	Hydro Unit quantity must be matched with outdoor unit 1 by 1. Check the Hydro Unit quantity. It must be 1EA.	●	○	○
E203	Communication error between Indoor/outdoor INV ↔ MAIN MICOM (1 min)	Check MAIN MICOM Check INVERTER MICOM	●	●	○
E221	Outdoor temperature sensor error	Check sensor connection status Check sensor location Check sensor resistance	●	○	○
E231	Cond temp sensor error	Check sensor connection status Check sensor location Check sensor resistance	●	○	○
E251	[Inverter] Emission temperature sensor error	Check sensor connection status Check sensor location Check sensor resistance	●	○	○
E320	OLP sensor error	Check sensor connection status Check sensor location Check sensor resistance	●	○	○
E403	Detection of Outdoor Freezing when Comp Stop	Check outdoor cond.	●	○	○
E404	Protection of Outdoor Overload when Comp Stop	Check comp.	●	○	○
E407	HIGH PRESS SWITCH ERROR	Check refrigerant pipe line blockage Check high pressure sensor Check refrigerant amount	●	○	○
E416	Discharge over temp error when Comp Stop	Check the operation setting state Check temperature sensor	●	○	○
E419	Outdoor EEV open error	Check the EEV of Outdoor Check the EEV connector to the PCB	●	○	○
E425	3Phase power source miss wiring error	Check the 3-phase inspection part power of the outdoor unit PCB.	●	○	○
E439	Gas leakage error(Stop state)	Check Refrigerant leakage and shortage Check Disconnection or breakdown of high & low pressure sensor	●	○	○
E440	Heating operation blocked	Check the operation setting state Check temperature sensor	●	○	○
E441	Cooling operation blocked	Check the operation setting state Check temperature sensor	●	○	○
E443	Gas leakage error(before operating)	Check Refrigerant leakage and shortage Check Disconnection or breakdown of high pressure sensor	●	○	○
E458	Outdoor fan 1 error	Check input power connection status Check the connection status between the motor and outdoor unit PCB Check indoor/outdoor fuse	○	○	●
E461	[Inverter] Compressor startup error	Check the compressor connection status Check the resistance between difference phases of the compressor	○	○	○
E462	[Inverter] Total current error/ PFC over current error	Check the input power Check the coolant charging status Check the normal operation of outdoor fan	●	○	○
E463	OLP over heat and comp stop	Check OLP sensor	●	○	○
E464	[Inverter] IPM over current error	Check coolant charging Check the compressor connection status and normal operation Check the obstacles around the indoor and outdoor units Check whether the outdoor unit service valve is open Check whether the indoor/outdoor installation pipe/wiring are correct	○	○	○

○ Off    ○ Blink    ● On

Error No.	Contents	Measure	LED Display		
			Red	Green	Yellow
E465	Compressor V limit error	Check the compressor connection status Check the resistance between difference phases of the compressor	○	●	◉
E466	DC LINK over/low voltage error	Check input power Check AC power connection	◉	●	○
E467	[Inverter] Compressor rotation error	Check the compressor connection status Check the resistance between difference phases of the compresso	●	○	●
E468	[Inverter] Current sensor error	Check EEPROM DATA Check the normal operation of PCB	●	◉	◉
E469	[Inverter] DC LINK voltage sensor error	Check the input power connection Check the status of RY21 and R200 in the INVERTER PCB	●	◉	○
E470	Outdoor EEPROM data checksum error	Check EEPROM DATA loading	●	◉	○
E471	Outdoor EEPROM hardware read/write error	Check EEPROM DATA Check the normal operation of PCB	●	◉	○
E474	Heatsink sensor error	Check the condition of heatsink assembly.	◉	◉	○
E475	Outdoor fan 2 error	Check the input power connection status Check the connection status of the motor and the outdoor unit PCB Check the indoor/outdoor unit fuse	○	○	●
E484	PFC overload error	Check reactor located in control plate. If reactor is normal, exchange INVERTER PBA.	●	◉	●
E485	Input current sensor error	Check Input current sensor on Inverter PCB.	●	◉	○
E500	IPM is over heated.	Check INVERTER PBA's temperature. Power off and cool down INVERTER PBA, and then restart the outdoor unit.	◉	◉	○
E554	Gas leak error	Check the coolant charging status Check the indoor EVA sensor Check if the outdoor unit service valve is open Check that the indoor/outdoor installation pipe/wiring are correct	●	◉	○
E901	Water inlet (PHE) temp sensor error (Short/Open)	Check sensor connection status Check sensor location Check sensor resistance	●	◉	○
E902	Water outlet (PHE) temp sensor error (Short/Open)	Check sensor connection status Check sensor location Check sensor resistance	●	◉	○
E906	Refrigerant gas inlet temp sensor error (Short/Open)	Check sensor connection status Check sensor location Check sensor resistance	●	◉	○

○ Off    ◉ Blink    ● On

### 4-2-1 Temperature sensor errors (E221,E231,E251,E320,E901,E902,E906)

1. Check items
  - 1) Is the sensor connected correctly (CN43 in MAIN PBA)?
  - 2) Is the position of sensor correct?

2. Check procedure

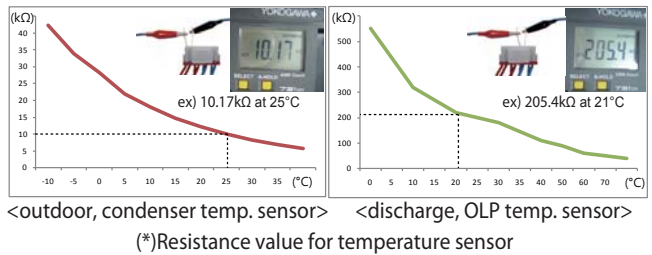
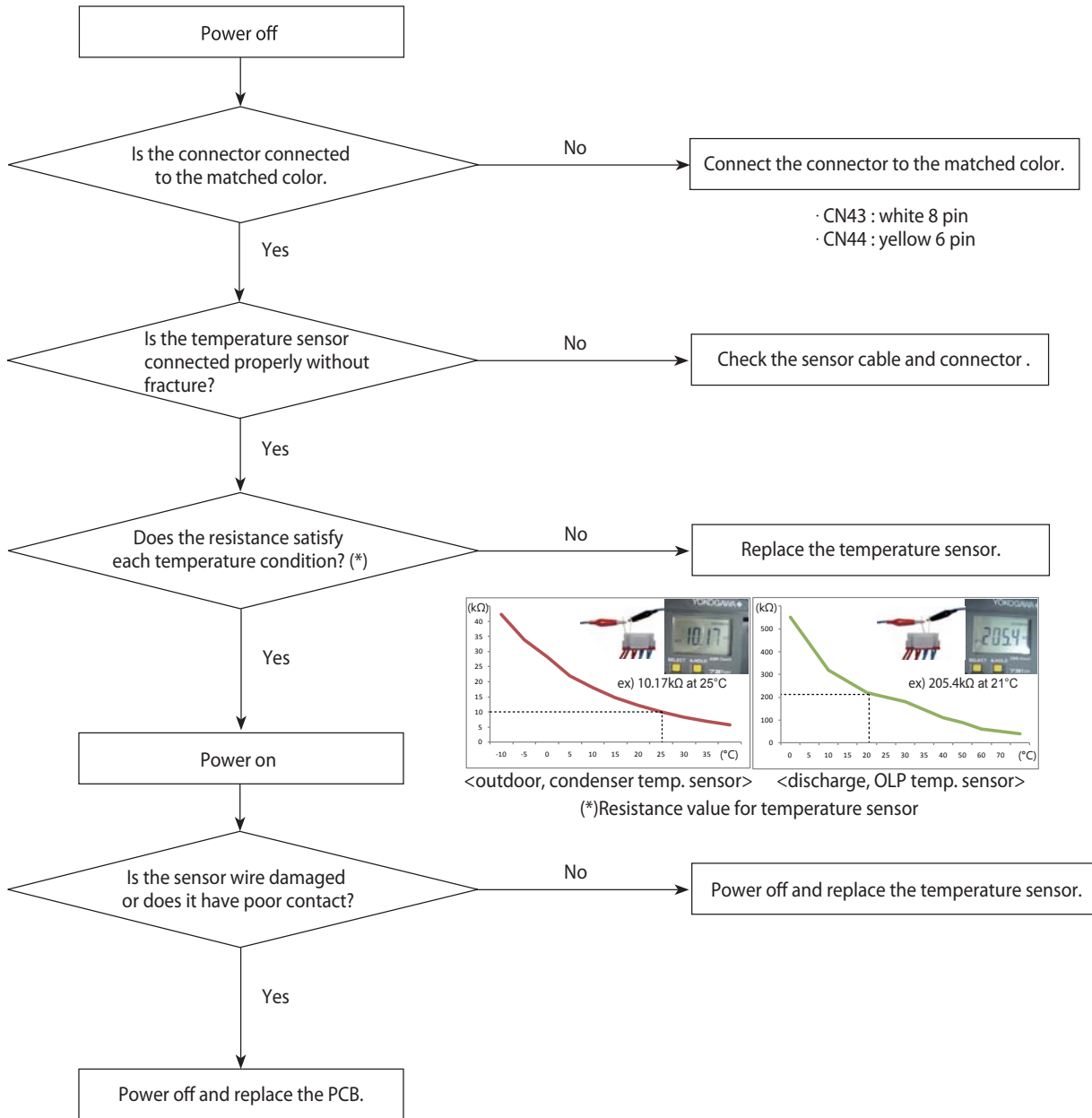

<Error code for each temperature sensor>

CN 44 in main PBA	Pin no.	Temp. sensor	Error code
	5,6	Water inlet (PHE)	E901
	3,4	Water outlet (PHE)	E902
	1,2	Refrigerant inlet (PHE)	E906

Temp. sensor	Error Code
Water inlet (PHE)	E901
Water outlet (PHE)	E902
Refrigerant inlet (PHE)	E906

### 4-2-2 Compressor errors (E404, E461, E467)

1. Check items
  - 1) Is the power connected properly?
  - 2) Is the connector of compressor connected correctly?
2. Check procedure

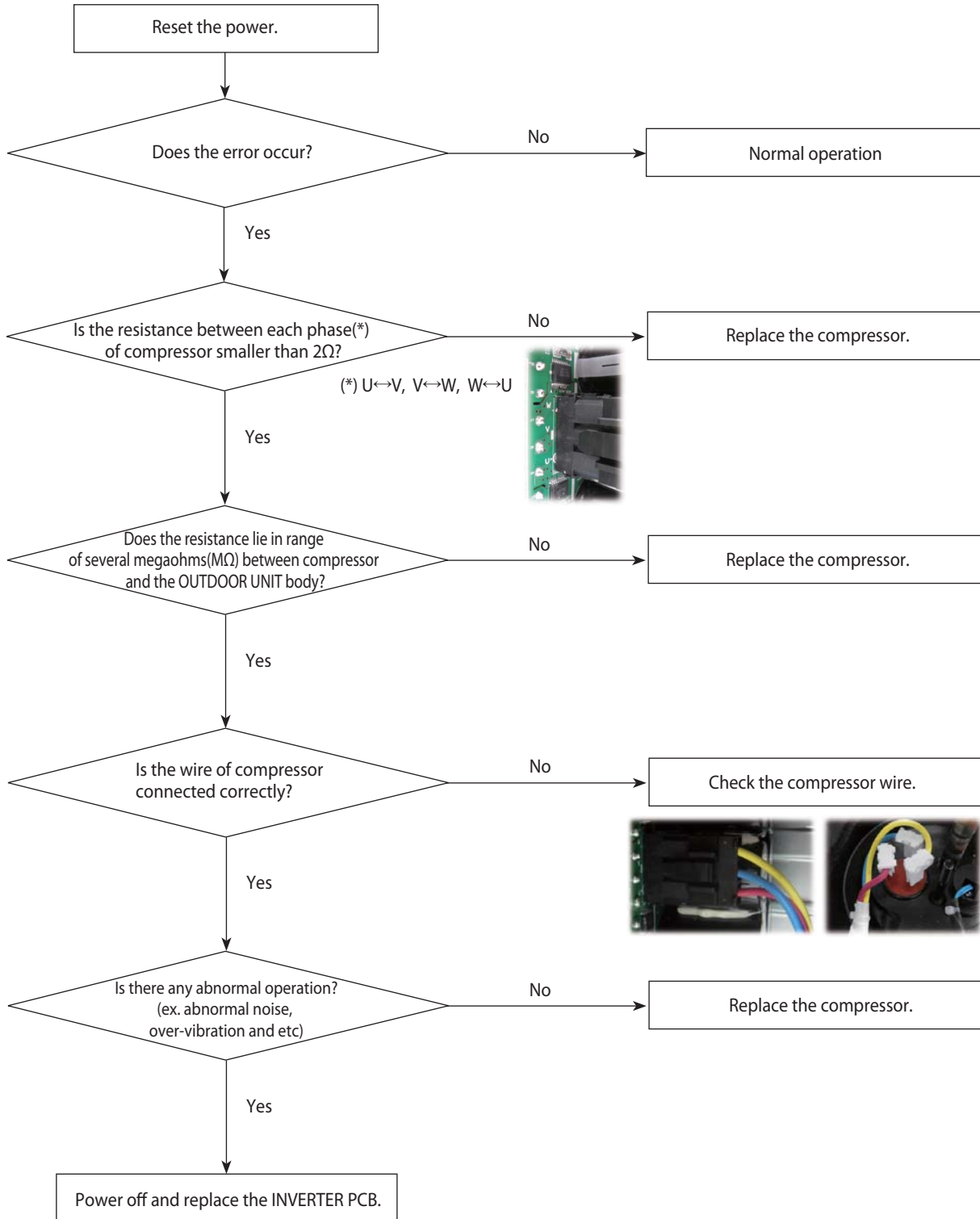



### 4-2-3 High pressure switch protection error (E407)

1. Check procedure

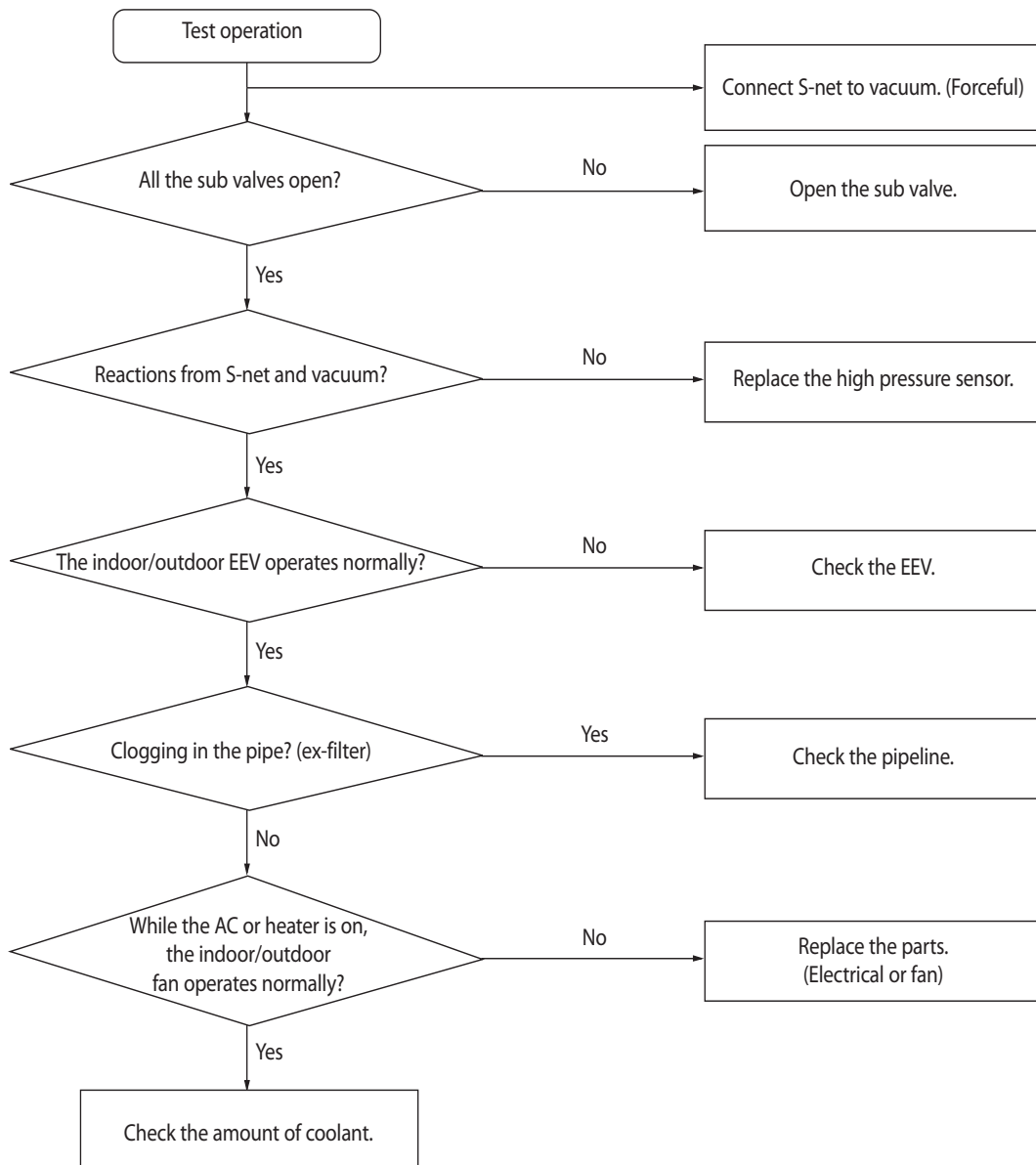

### 4-2-4 Compressor discharge error (E416)

1. Check items
  - 1) Does the compressor rotate normally?
  - 2) Is the discharge sensor normal ?
2. Check procedure

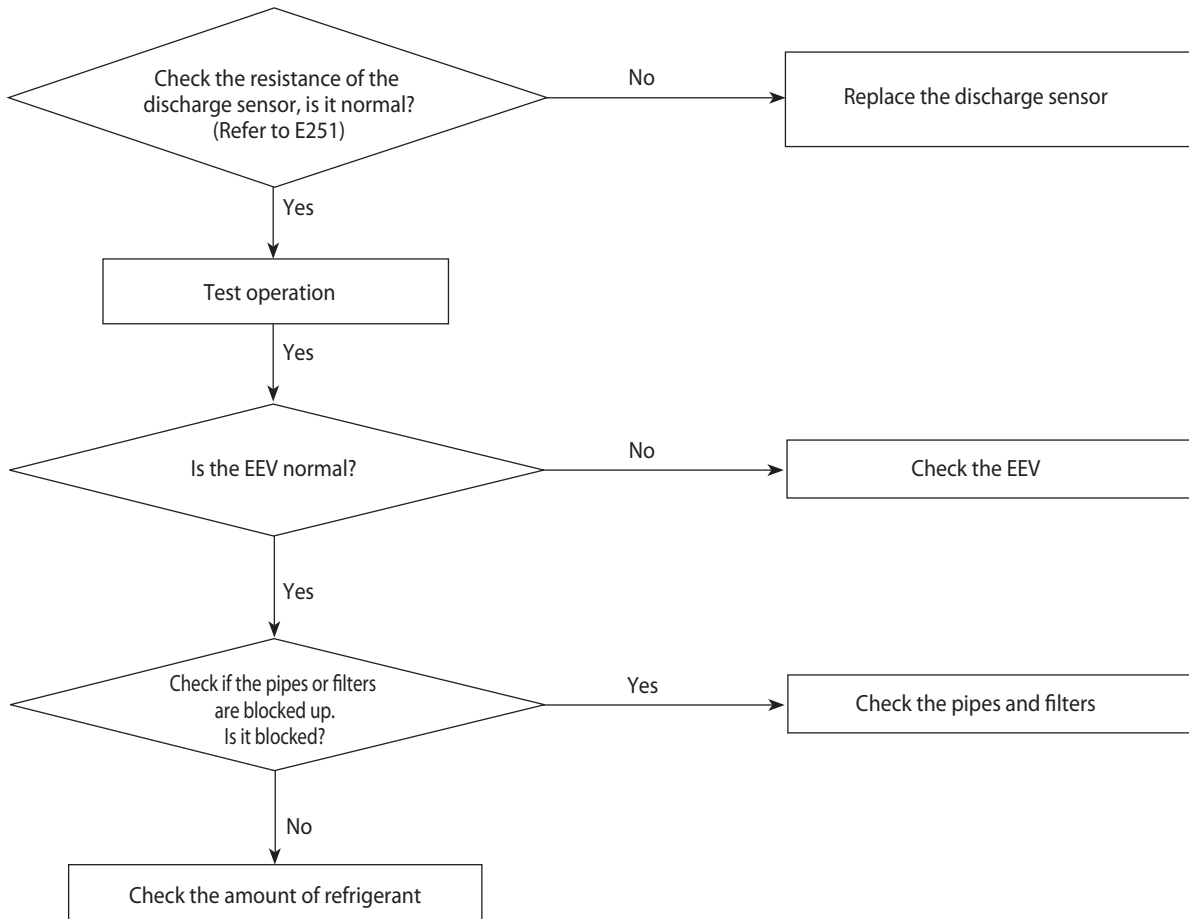

### 4-2-5 EEV error (E419)

1. Check items
  - 1) Does the compressor rotate normally?
  - 2) Is the OLP sensor normal?
2. Check procedure

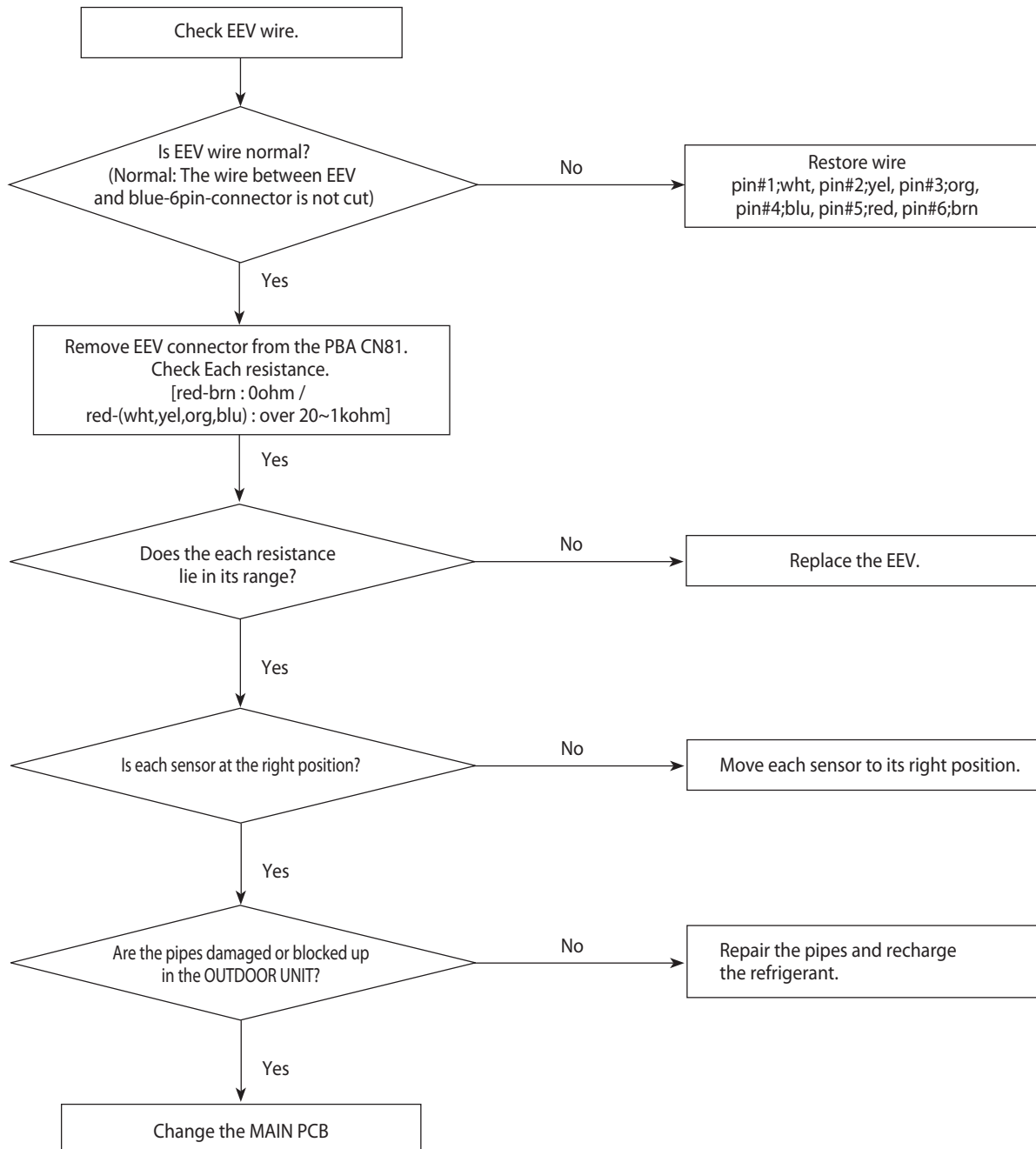

### 4-2-6 Fan errors (E458, E475)

#### FAN 1 error(E458), FAN 2 error(E475)

1. Check items
  - 1) Are the input power voltage and power connected correctly?
  - 2) Is the motor wire connected to the OUTDOOR UNIT PCB correctly?
  - 3) Is there any obstacle around the motor and fan?
  - 4) Is the driver in the motor case damaged?
  - 5) Fan connector must be connected with CN90 for 1 fan model (BLDC FAN1).

2. Check procedure

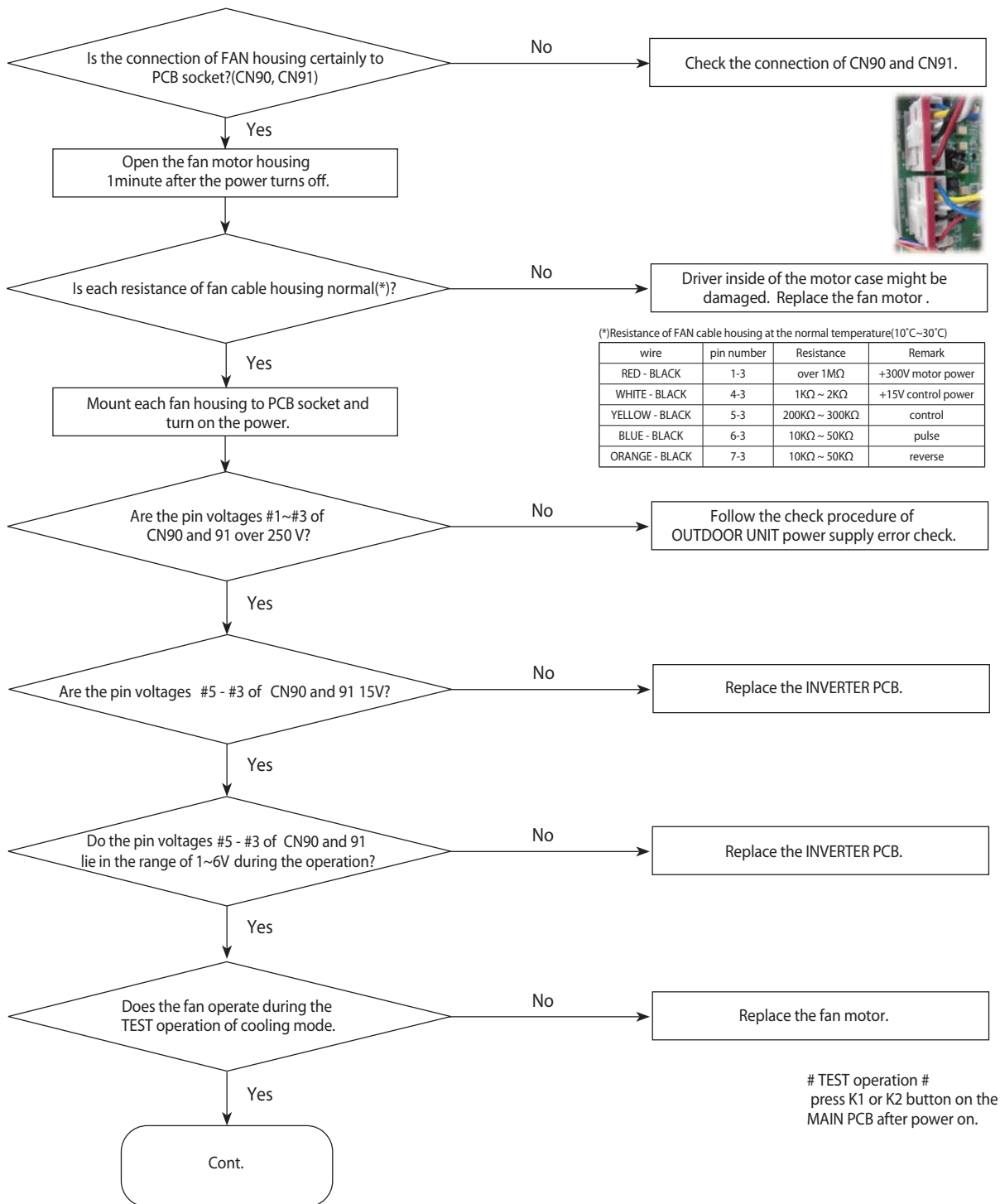

**FAN 1 error(E458), FAN 2 error(E475)**

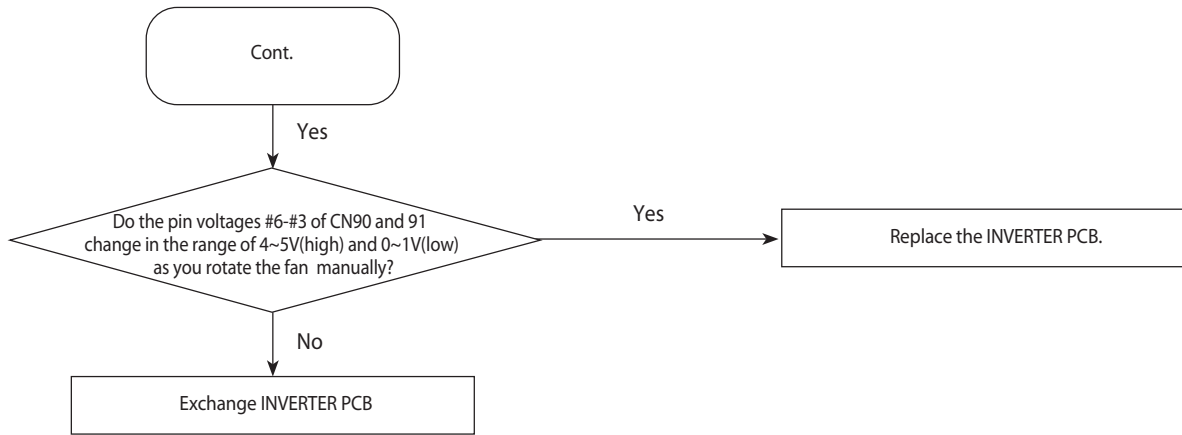

### 4-2-7 Current trip errors (E462, E463, E464, E465)

**Primary current trip error(E462), Over current trip / PFC over current error(E463), IPM over current error (E464), Compressor voltage limit error (E465)**

1. Check items
  - 1) Is the voltage of power suitable?
  - 2) Is refrigerant charged?
  - 3) Does the OUTDOOR UNIT fan operate normally?
  - 4) Is there any obstacle around OUTDOOR UNIT?
2. Check procedure

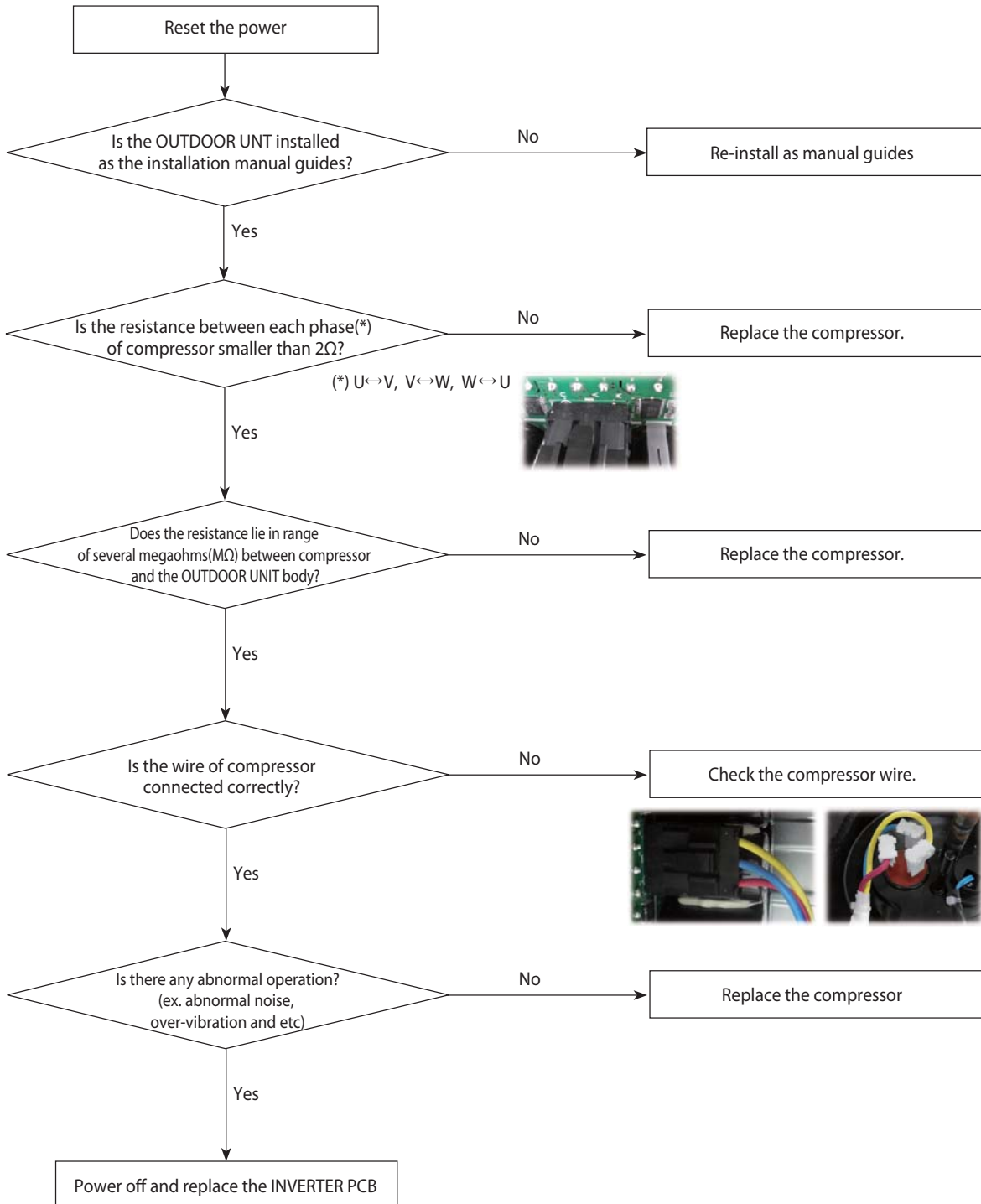

### 4-2-8 DC-link voltage under/over error (E466)

1. Check items
  - 1) Is the input power normal?
  - 2) Is the AC power connected correctly?

2. Check procedure

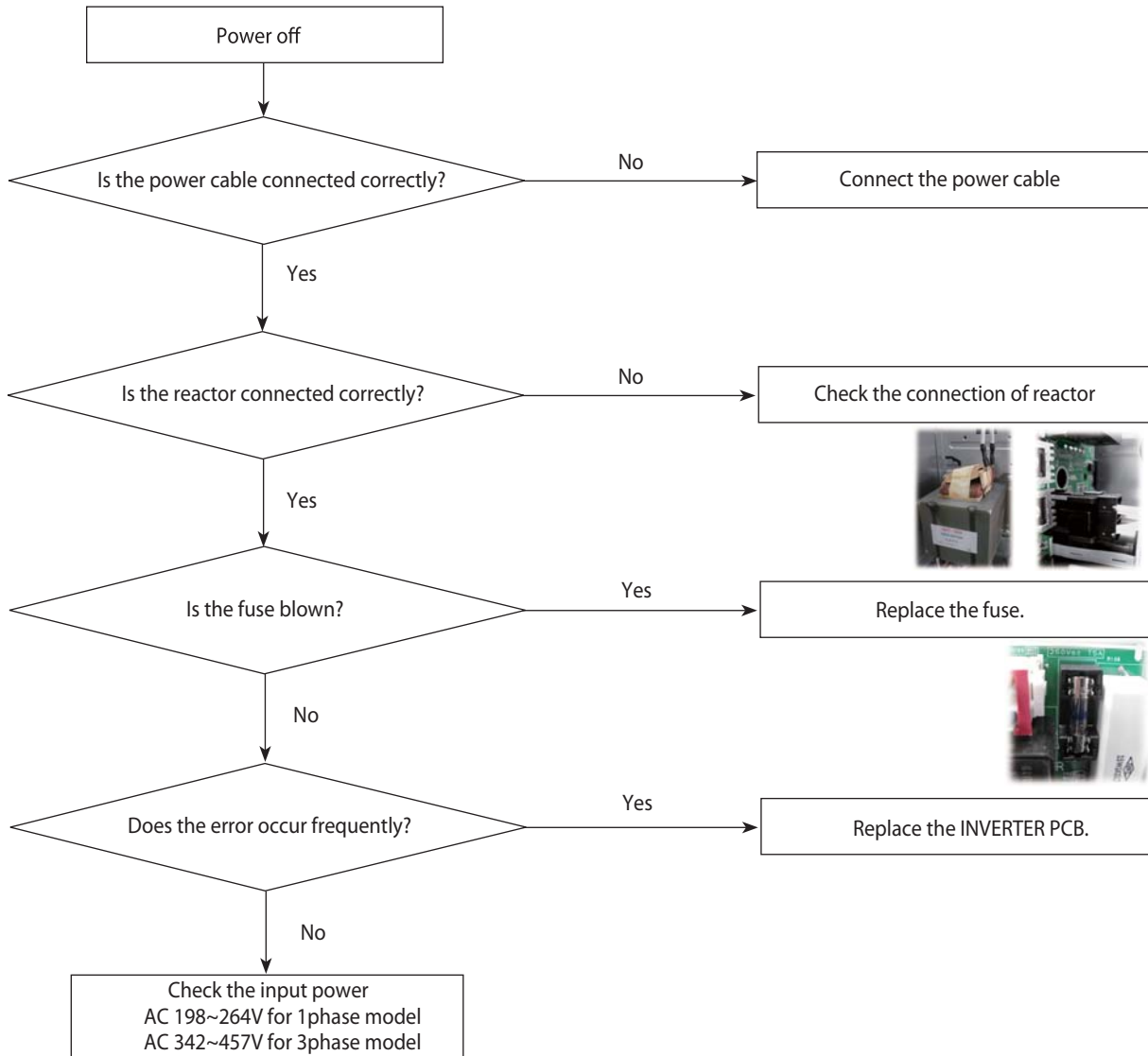

### 4-2-9 IPM overheating error (E500)

1. Check items
  - 1) Can the Heatsink at the control-box be cool ?
  - 2) Are the PCB and the Heatsink combined well?
2. Check procedure

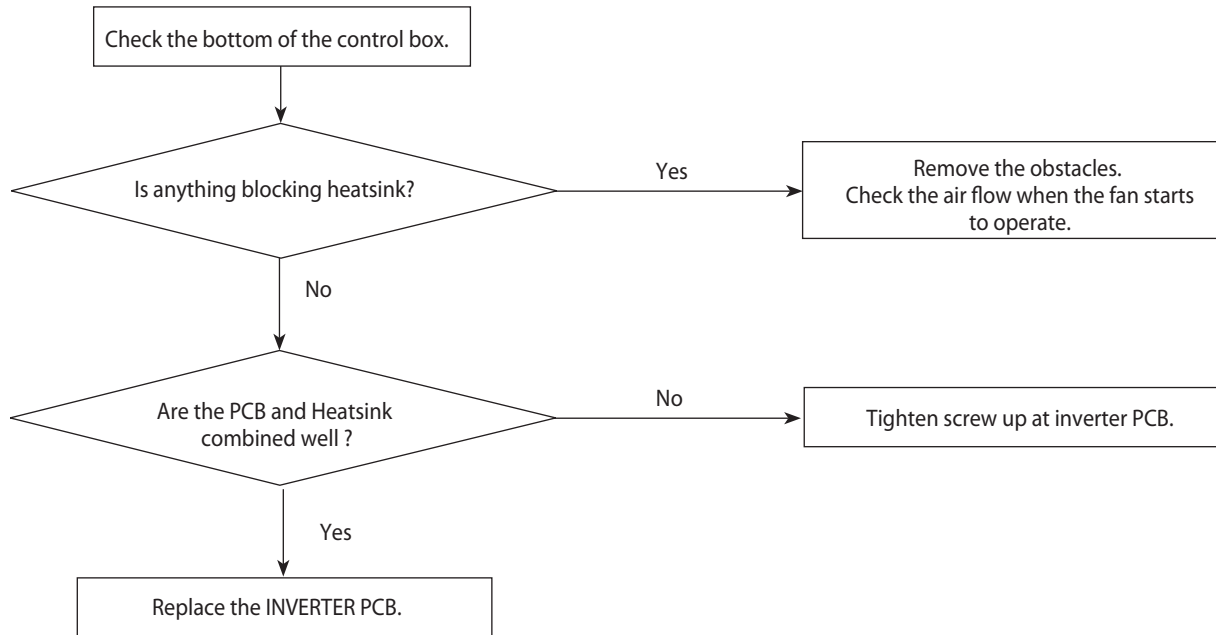



### 4-2-10 Gas leakage error (E554)

1. Check procedure

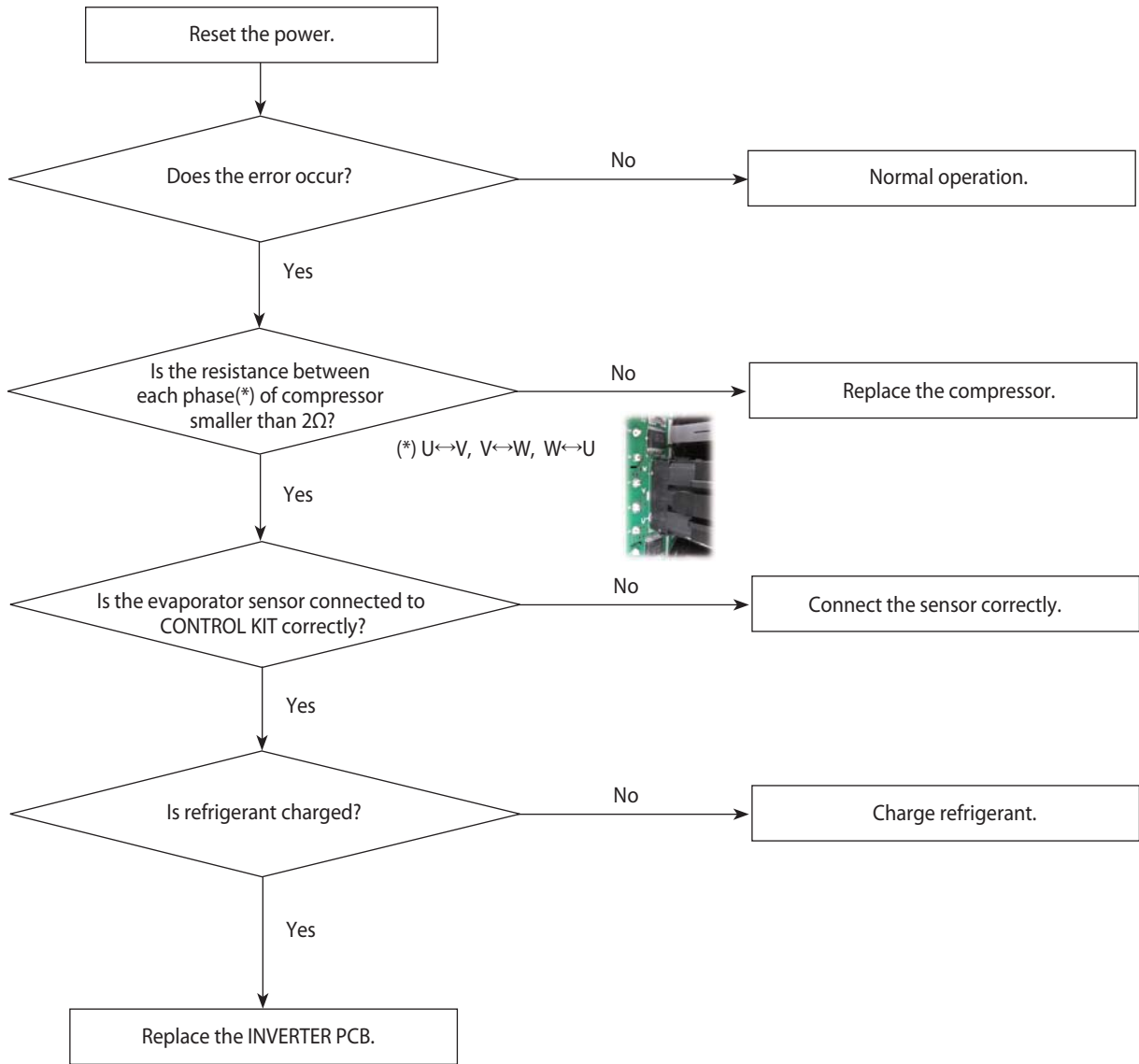

## 4-3 CONTROL KIT & wired remote controller errors

- If an error occurs, (  ) icon will be displayed on the wired remote controller.
- Press the Test button to see the error code.

Display	Explanation	Error Source
101	CONTROL KIT / OUTDOOR UNIT wire connection error	CONTROL KIT, OUTDOOR UNIT
162	EEPROM Error	CONTROL KIT
198	Error of Terminal Block's Thermal Fuse(Open)	CONTROL KIT
201	CONTROL KIT/OUTDOOR UNIT communication error (Matching error)	CONTROL KIT, OUTDOOR UNIT
202	CONTROL KIT/OUTDOOR UNIT communication error (3 min)	CONTROL KIT, OUTDOOR UNIT
203	Communication error between INVERTER and MAIN MICOM (6 min)	OUTDOOR UNIT
221	OUTDOOR UNIT temperature sensor error	OUTDOOR UNIT
231	condenser temperature sensor error	OUTDOOR UNIT
251	Discharge temperature sensor error	OUTDOOR UNIT
320	OLP sensor error	OUTDOOR UNIT
403	Detection of OUTDOOR UNIT compressor freezing (During cooling operation)	OUTDOOR UNIT
404	Protection of OUTDOOR UNIT when it is overload (during Safety Start, Normal operation state)	OUTDOOR UNIT
407	Comp down due to high pressure	OUTDOOR UNIT
416	Discharge of a compressor is overheated	OUTDOOR UNIT
425	Power source line missing error (only for 3-phase model)	OUTDOOR UNIT
440	Heating operation blocked (outdoor temperature over 35°C)	OUTDOOR UNIT
441	Cooling operation blocked (outdoor temperature under 9°C)	OUTDOOR UNIT
458	OUTDOOR UNIT fan1 error	OUTDOOR UNIT
461	[Inverter] Compressor startup error	OUTDOOR UNIT
462	[Inverter] Total current error/PFC over current error	OUTDOOR UNIT
463	OLP is overheated	OUTDOOR UNIT
464	[Inverter] IPM over current error	OUTDOOR UNIT
465	Compressor V limit error	OUTDOOR UNIT
466	DC LINK over/low voltage error	OUTDOOR UNIT
467	[Inverter] Compressor rotation error	OUTDOOR UNIT
468	[Inverter] Current sensor error	OUTDOOR UNIT
469	[Inverter] DC LINK voltage sensor error	OUTDOOR UNIT
470	EEPROM Read/Write error	OUTDOOR UNIT
471	[Inverter] OTP error	OUTDOOR UNIT
474	IPM(IGBT Module) or PFCM temperature sensor Error	OUTDOOR UNIT
475	OUTDOOR UNIT fan2 error	OUTDOOR UNIT
484	PFC Overload Error	OUTDOOR UNIT
485	Input current sensor error	OUTDOOR UNIT
500	IPM is overheated	OUTDOOR UNIT
554	Gas leak error	OUTDOOR UNIT
590	Inverter EEPROM Checksum error	OUTDOOR UNIT
601	Communication error between the CONTROL KIT and wired remote controller	Wired Remote Controller
602	Wired remote controller Master/Slave setting error	Wired Remote Controller
604	Communication tracking error between the CONTROL KIT and wired remote controller	CONTROL KIT, Wired Remote Controller
607	Communication error between the Master and Slave wired remote controllers	Wired Remote Controller
901	Water inlet (PHE) temperature sensor error(open/short)	OUTDOOR UNIT
902	Water outlet (PHE) temperature sensor error(open/short)	OUTDOOR UNIT
903	Water outlet (backup heater) temperature sensor error.	CONTROL KIT
904	DHW tank temperature sensor error	CONTROL KIT
906	Outdoor Eva Inlet Temp Sensor (open/short)	OUTDOOR UNIT
911	Flow switch and water pump error (F/S signal is OFF for 10 sec. during the water pump signal is ON)	CONTROL KIT
912	Flow switch and water pump error (Water pump signal is OFF for 60sec during the F/S signal is ON)	CONTROL KIT
916	Mixing valve temp sensor (open/short)	CONTROL KIT



When the product does not work during or after the concrete curing function and it displays "CC" on the wired remote controller, contact the installer to cancel the concrete curing function.

### 4-3-1 EEPROM Error (E162)

1. Check procedure

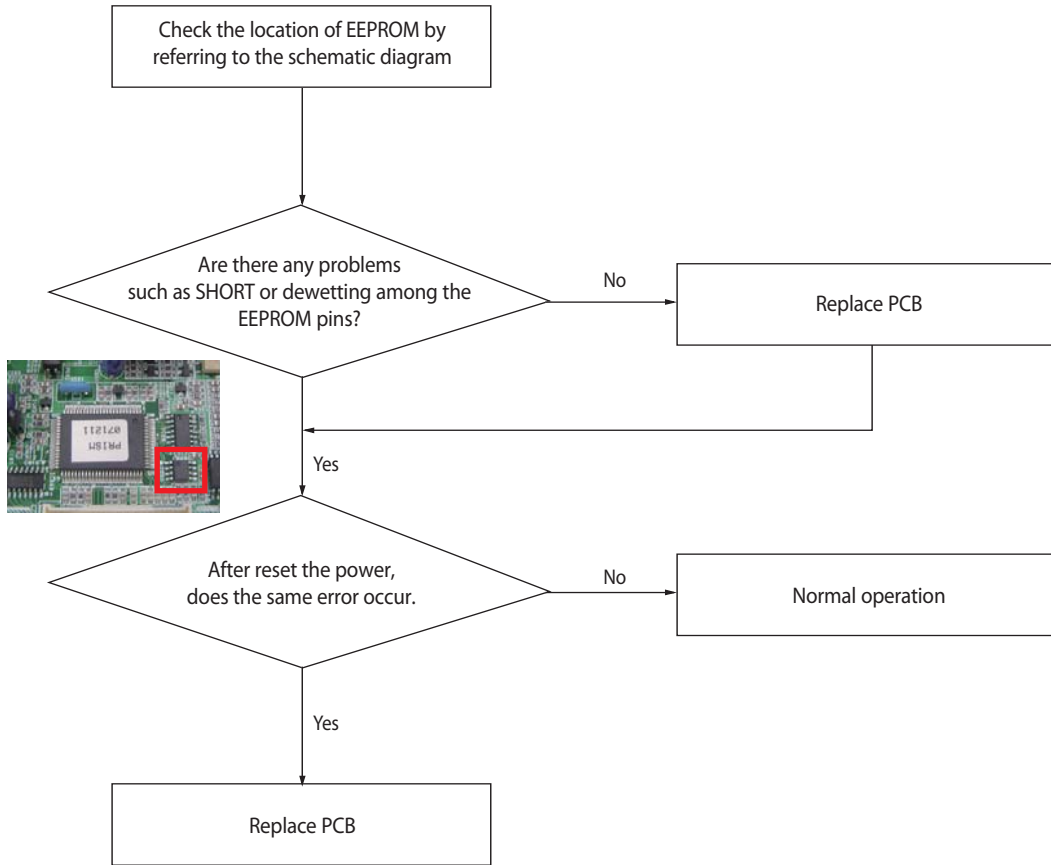

### 4-3-2 CONTROL KIT/OUTDOOR UNIT communication error (E202)

1. Check items
  - 1) Is the communication cable SHORT or OPEN?
  - 2) Is there a response from the CONTROL KIT PCB?
2. Check procedure

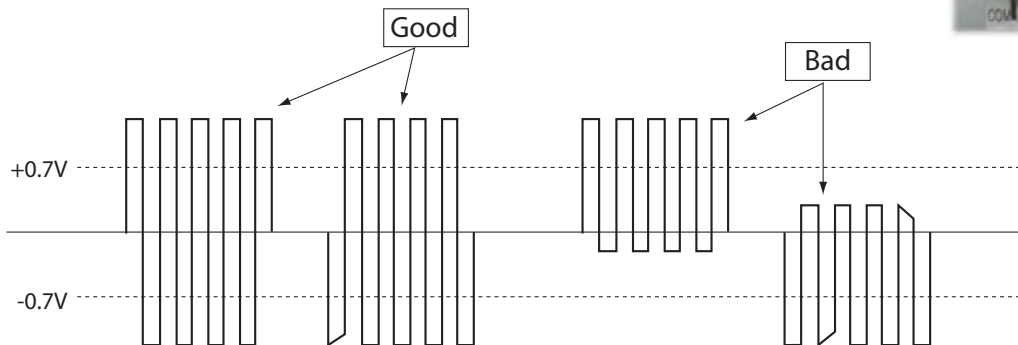
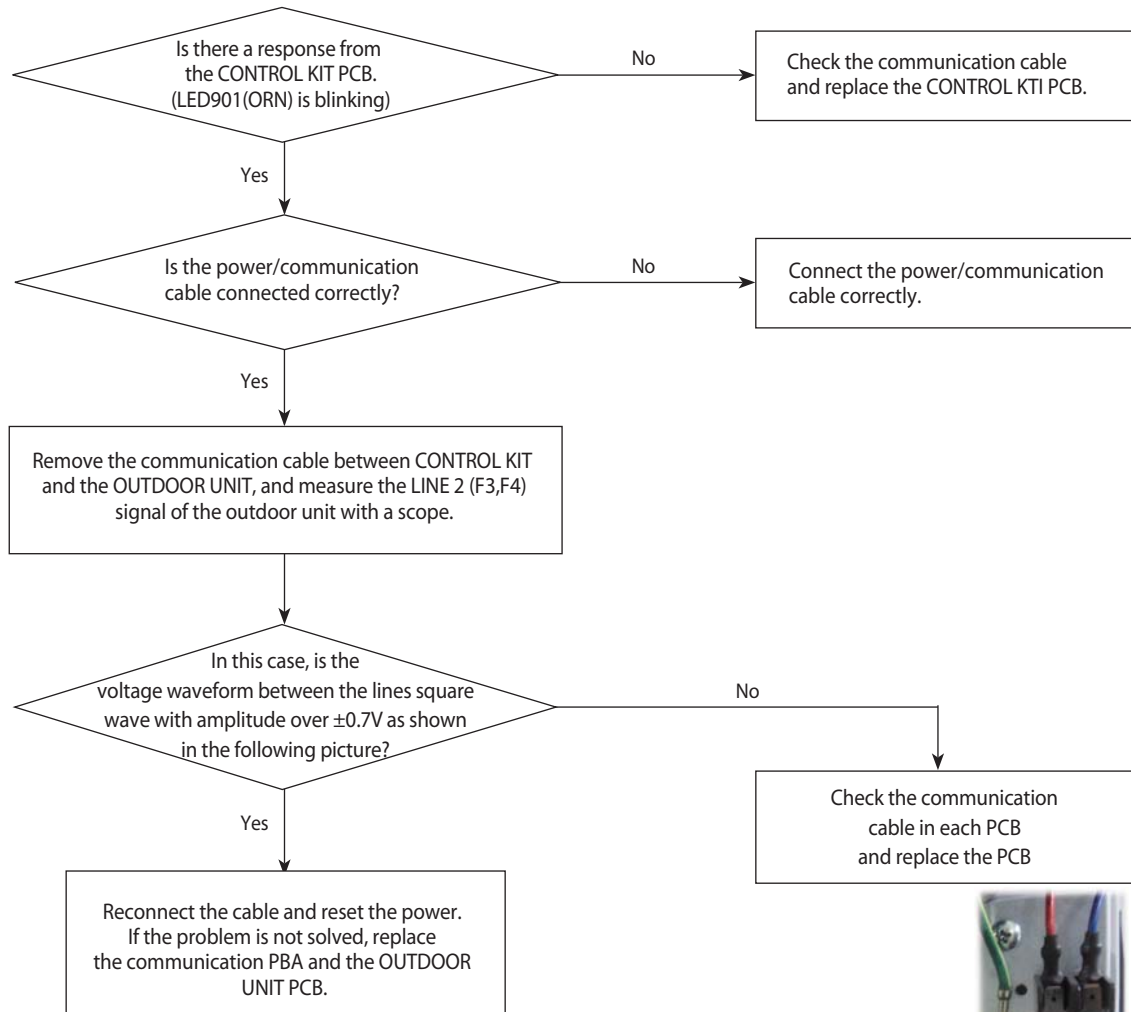

cf.) If there is no oscillo scope, it can be replaced multimeter instead of osillo scope.  
 If measured voltage is floating value from 0.1V to 4.5V, then it means that the PCB is normal.

### 4-3-3 Communication error between INVERTER and MAIN PBA (E203)

1. Check items
  - 1) Does the INVERTER PCB power light on?
  - 2) Check the power cable/fuse
  - 3) Does the INVERTER PCB (CN31) communicate well with MAIN PCB (CN39)
  - 4) Check the communication cable
2. Check Procedure

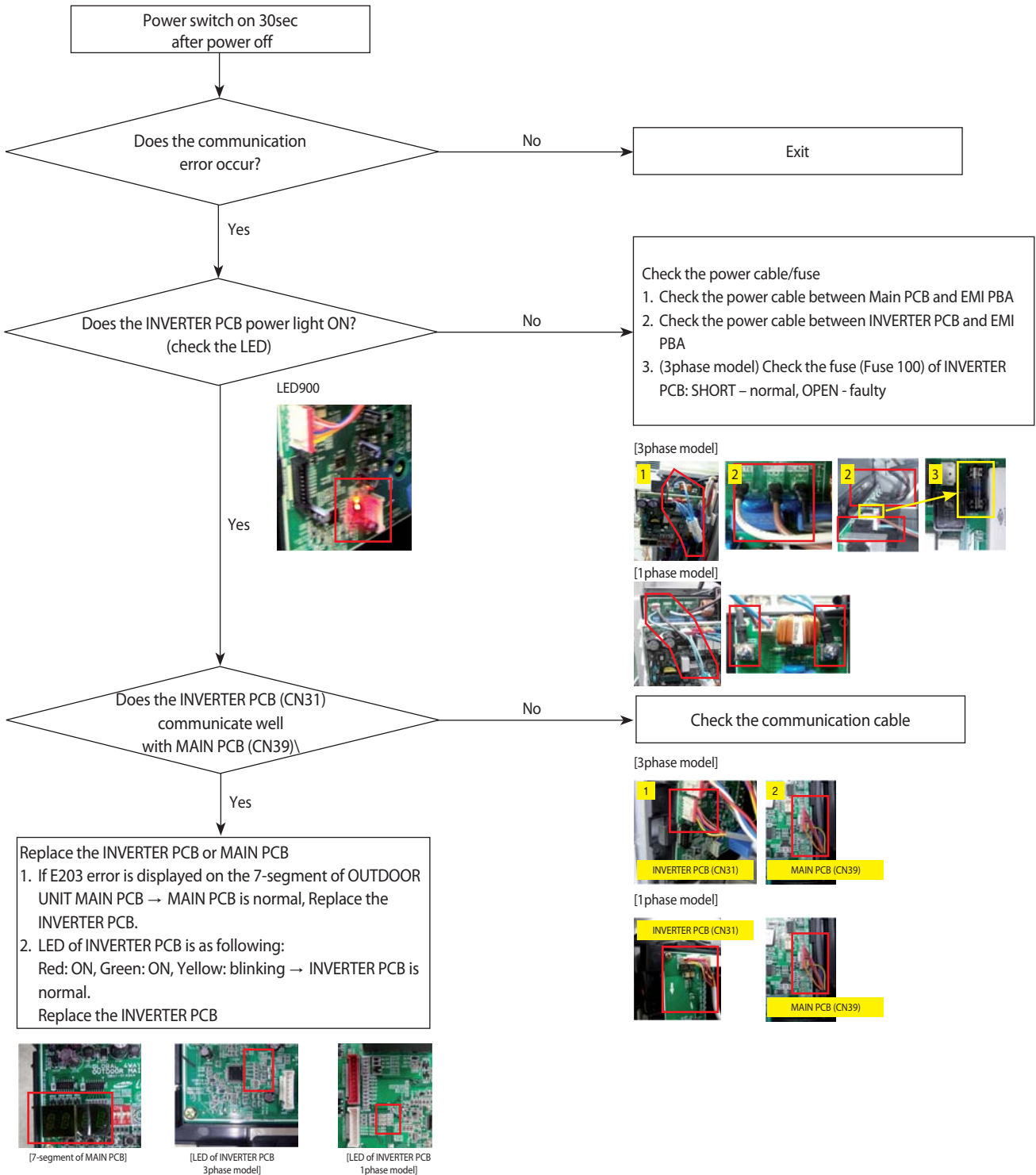

### 4-3-4 Communication tracking error(E604)

1. Check procedure

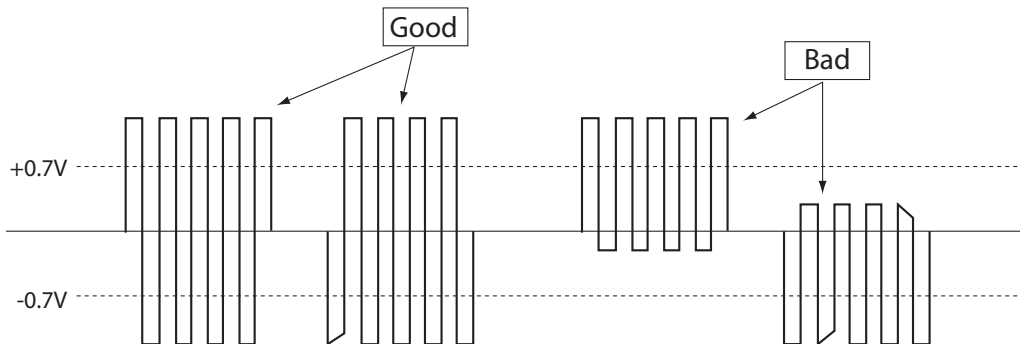
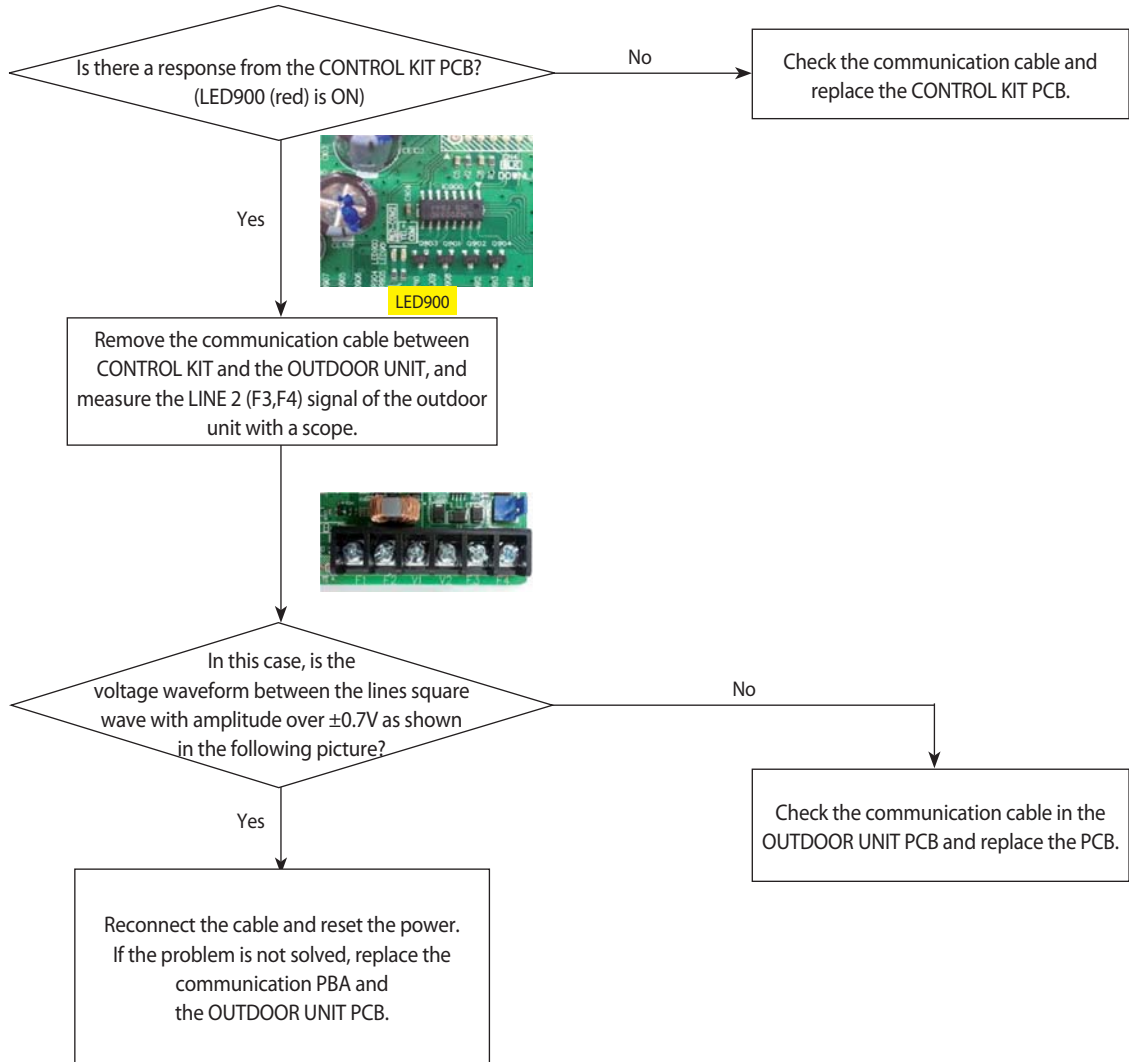

### 4-3-5 Water outlet (backup heater) temperature sensor error (E903)

1. Check procedure

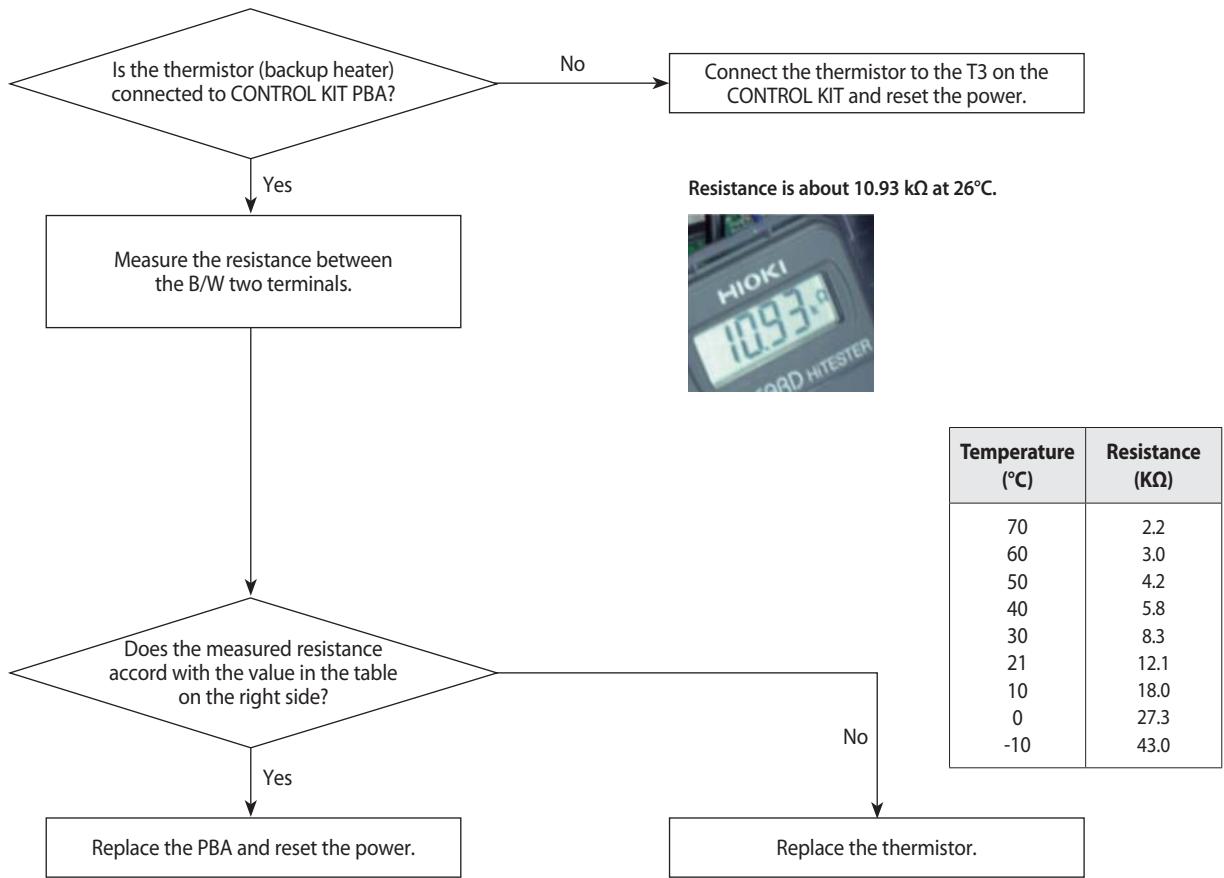

### 4-3-6 DHW tank temperature sensor error (E904)

1. Check procedure

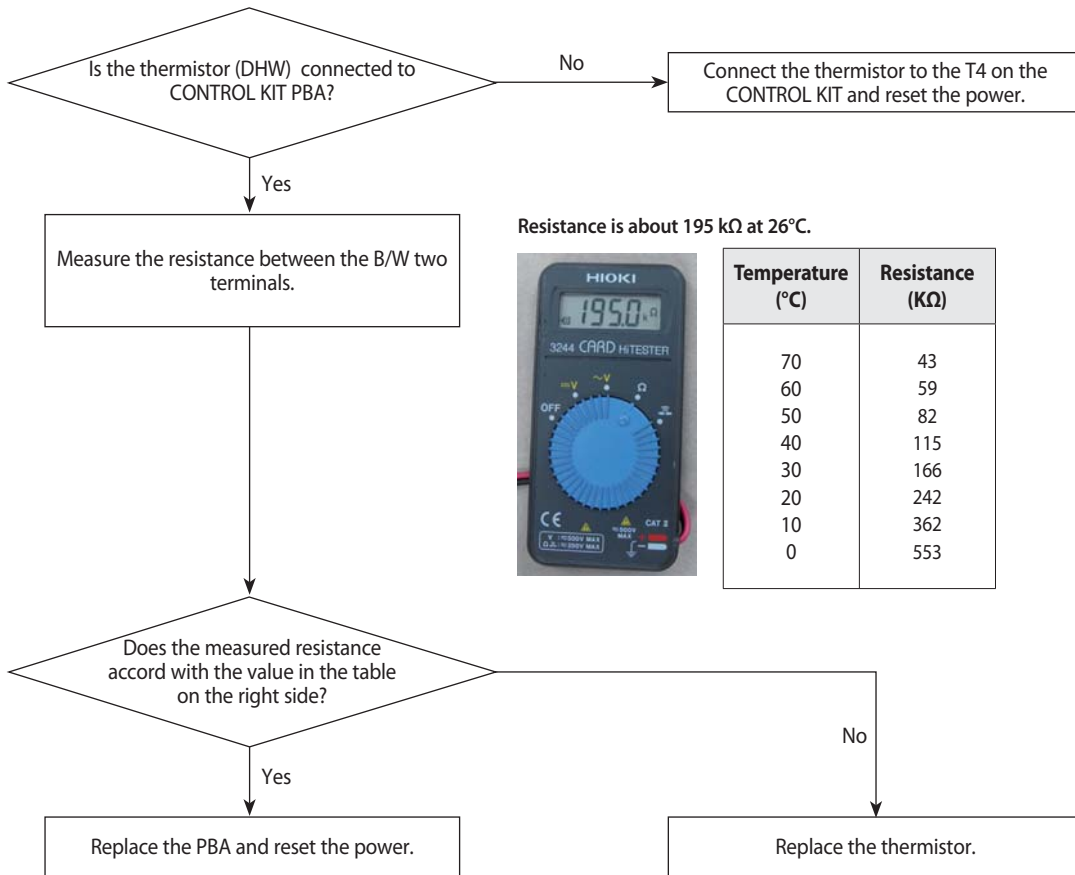



### 4-3-7 Flow switch (ON) and water pump (OFF) error (E911)

1. Check procedure

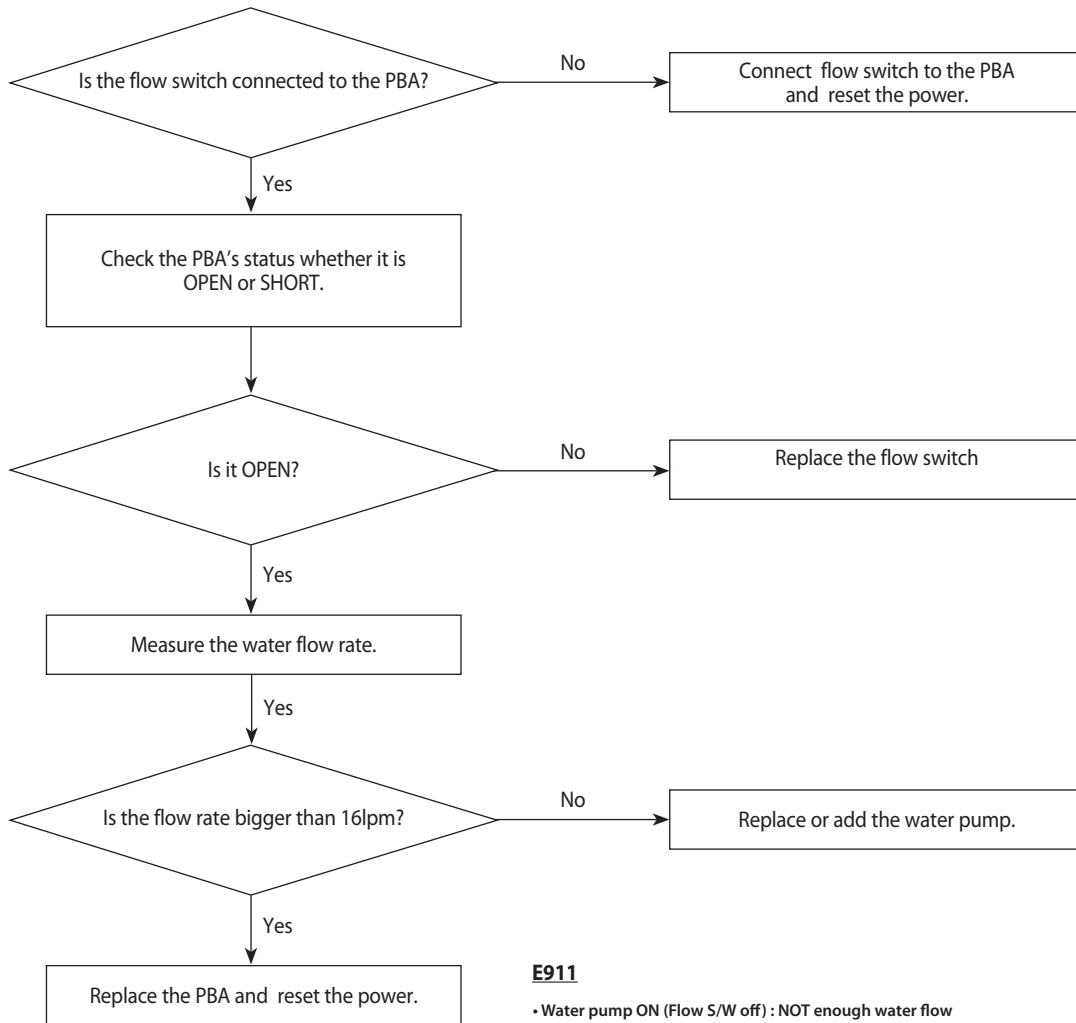

**E911**

• Water pump ON (Flow S/W off) : NOT enough water flow

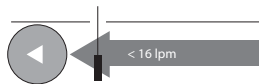

### 4-3-8 Flow switch (OFF) and water pump (ON) error (E912)

1. Check procedure

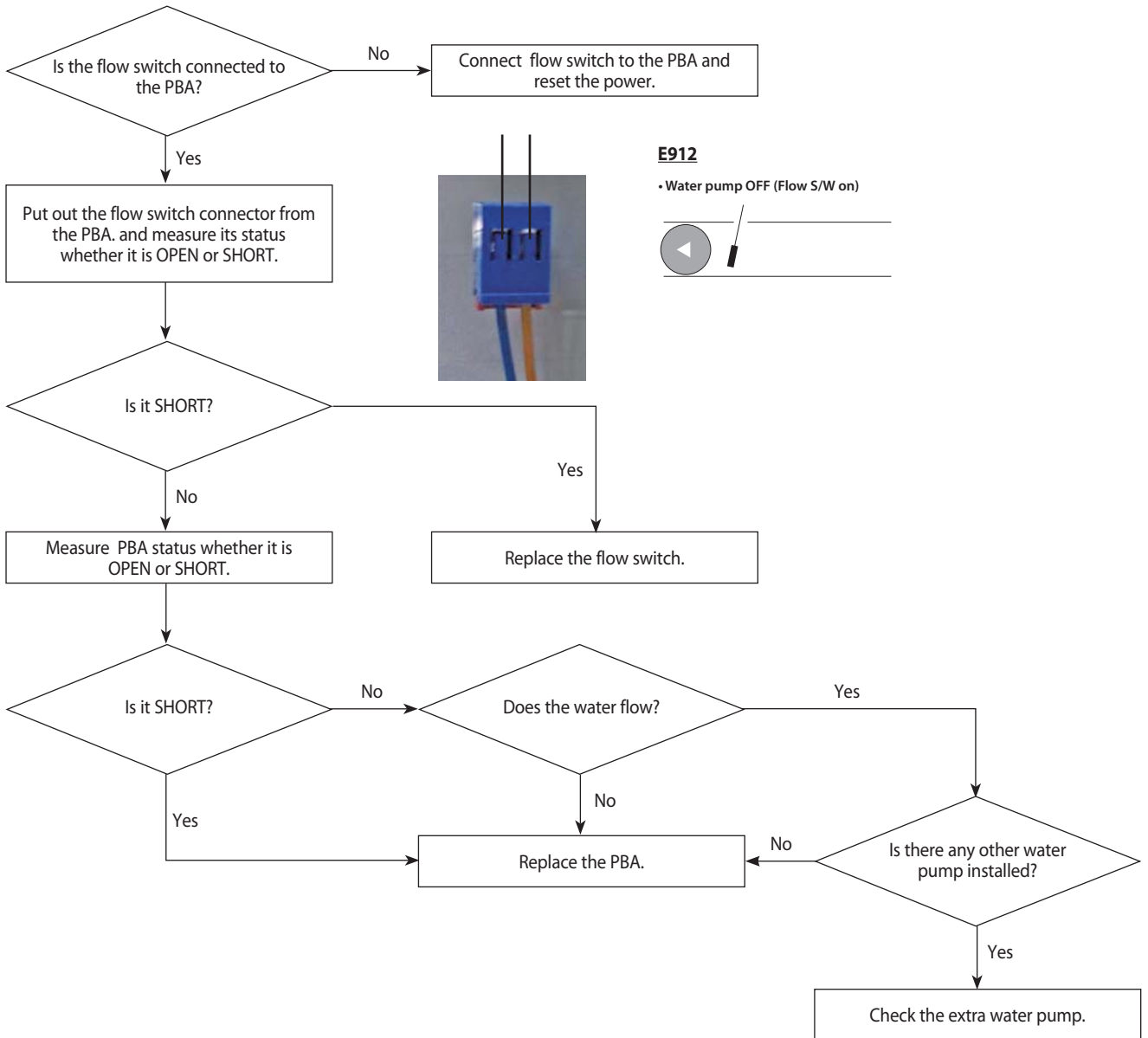

## 4-4 Other troubleshootings

### 4-4-1 Heating during the cooling mode / Cooling during the heating mode

#### 1. Troubleshooting procedure

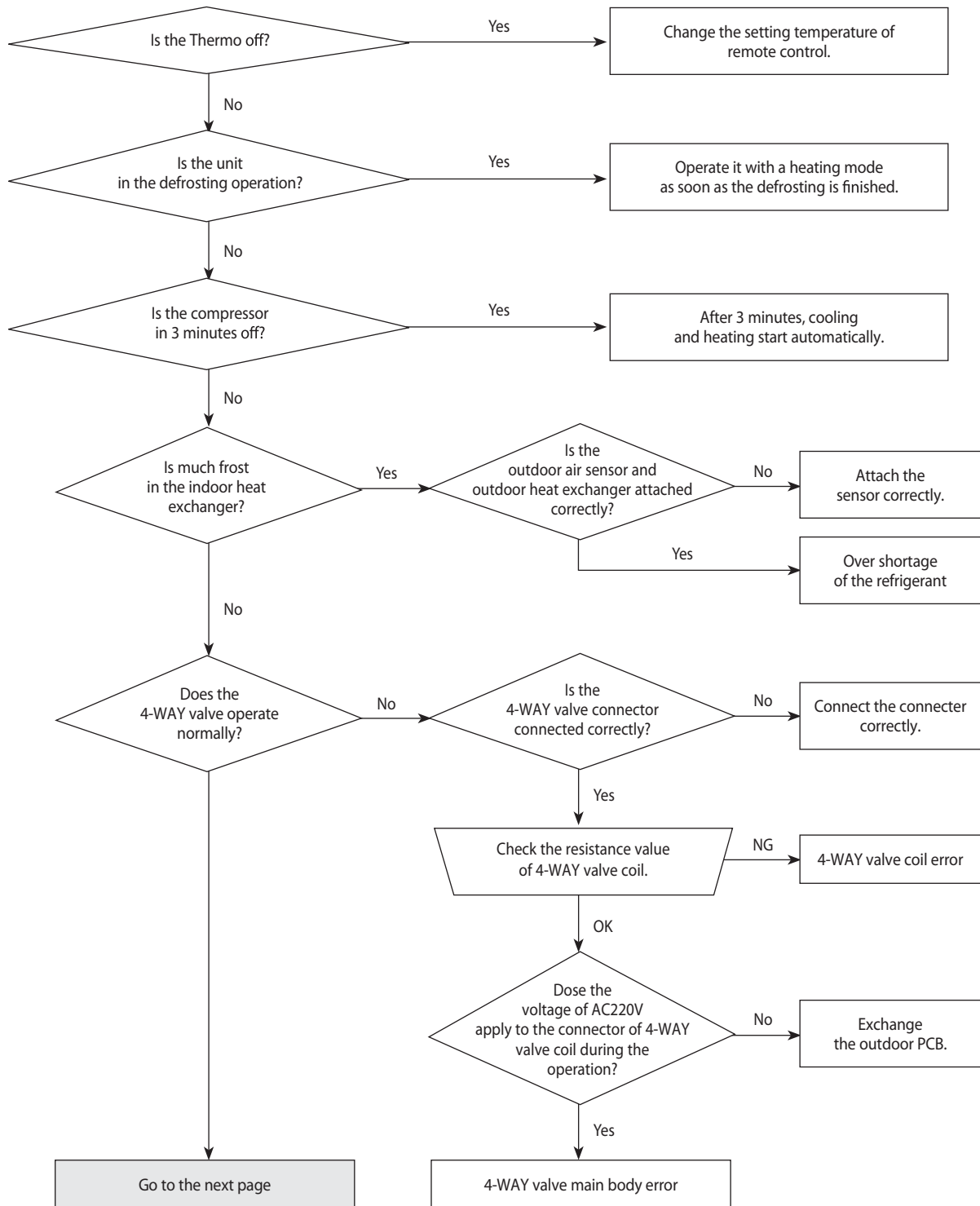

\* Normal resistance value of 4 way valve coil :  $1.5 \pm 0.15 k\Omega$  (at 20 °C)

Heating during the cooling mode / Cooling during the heating mode (cont.)

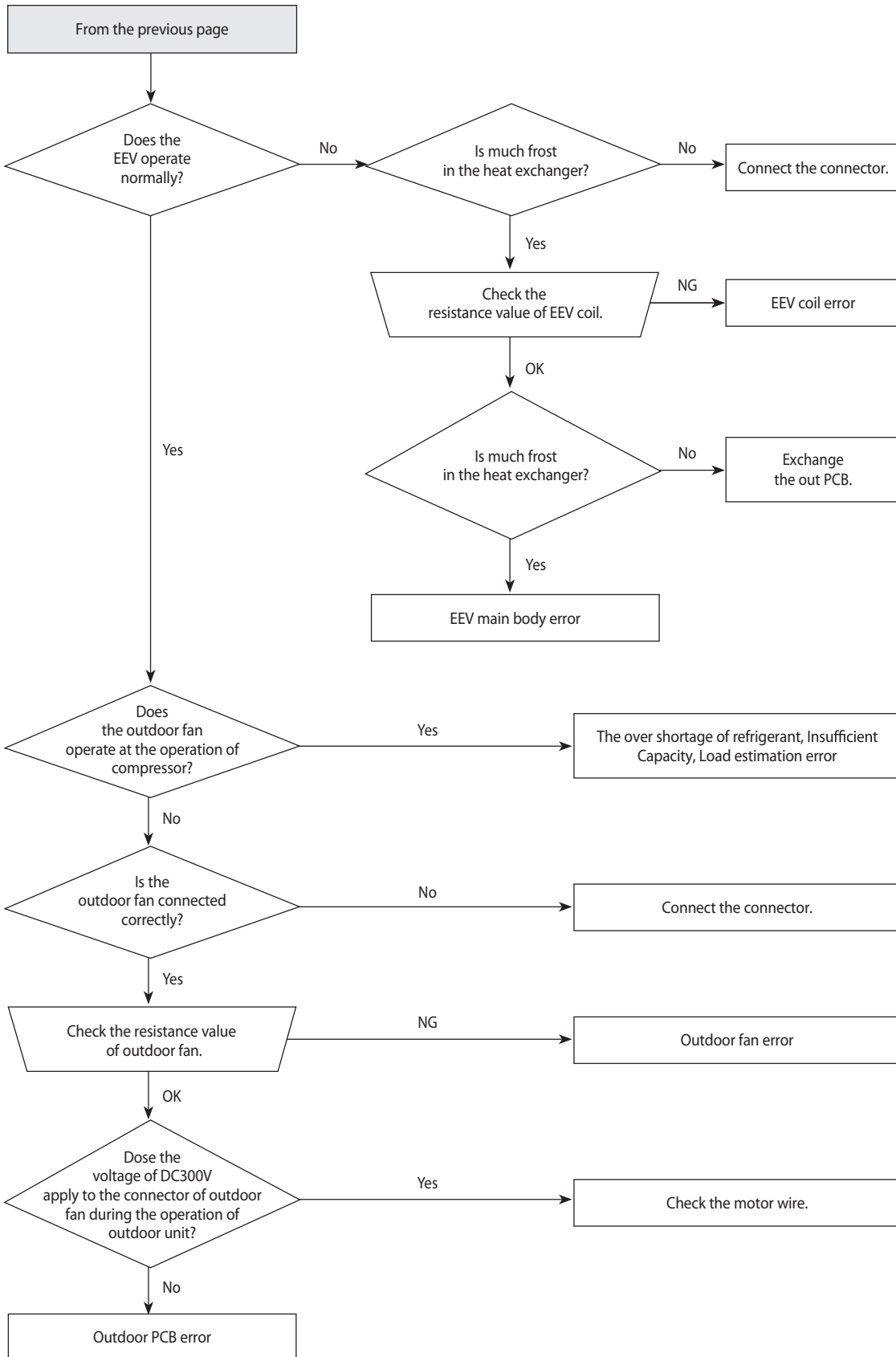

\* Normal resistance value of EEV valve coil(Red-Black or Yellow-Orange) :  $92 \pm 8\Omega$  (at 20°C)

### 4-4-2 Initial diagnosis when the OUTDOOR UNIT is not powered on

1. Check items
  - 1) Is the power supply voltage 380V?
  - 2) Is the AC power connected correctly?
  - 3) Are the LEDs in the main PCB and inverter PCB of the outdoor unit ON?
  - 4) Is the input power voltage of the indoor unit 220V?
  - 5) Is the wired remote controller connected correctly?
2. Check procedure

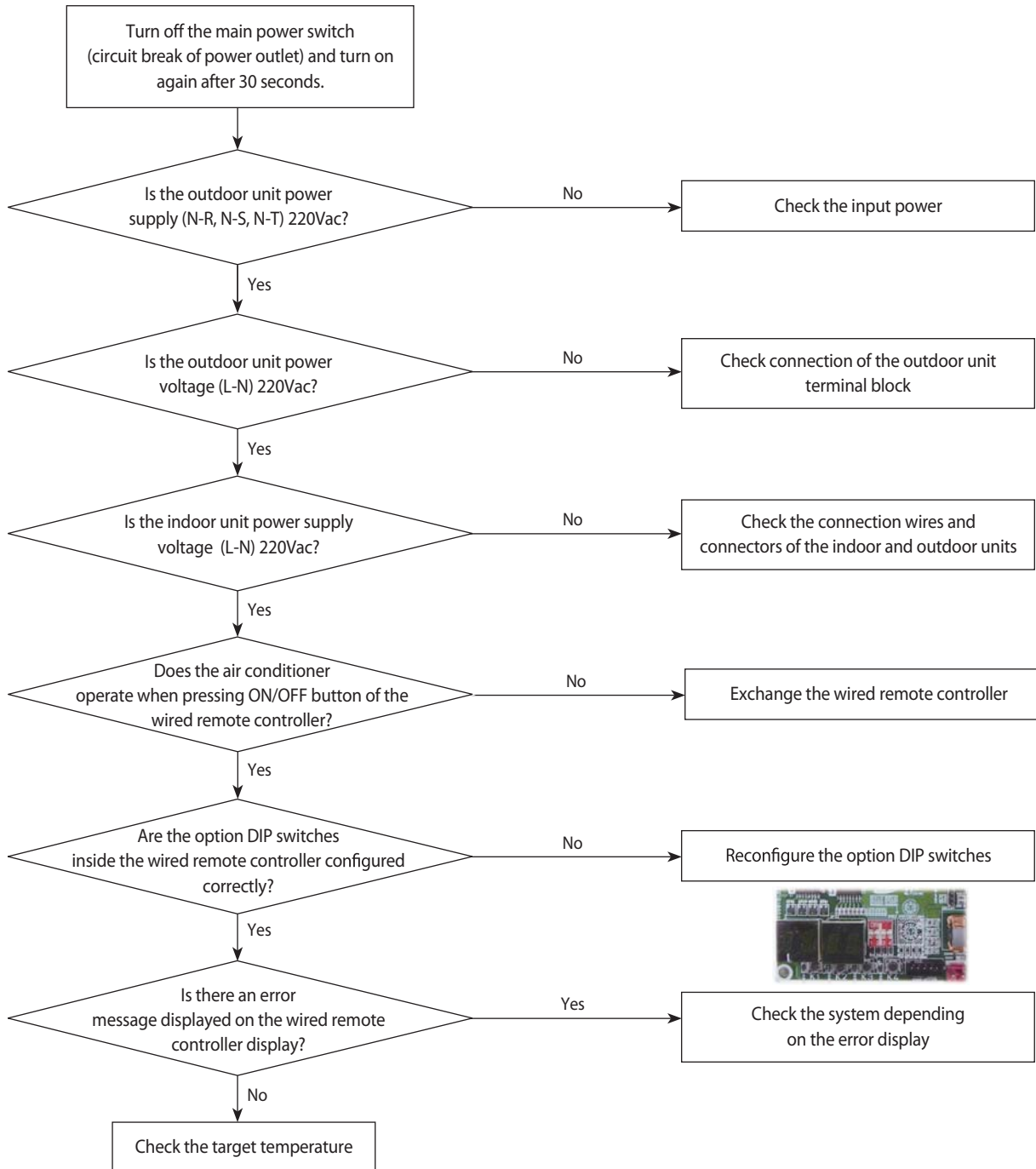

### 4-4-3 OUTDOOR UNIT power supply error

1. Checklist:
  - 1) Are the input power voltage and power connection correct?
  - 2) Is there any Fuse Short of the indoor or outdoor unit?
  - 3) Is any LED lit on both MAIN PCB and INVERTER PCB?
  - 4) Are Reactor wires of the outdoor unit connected correctly?

2. Troubleshooting procedure

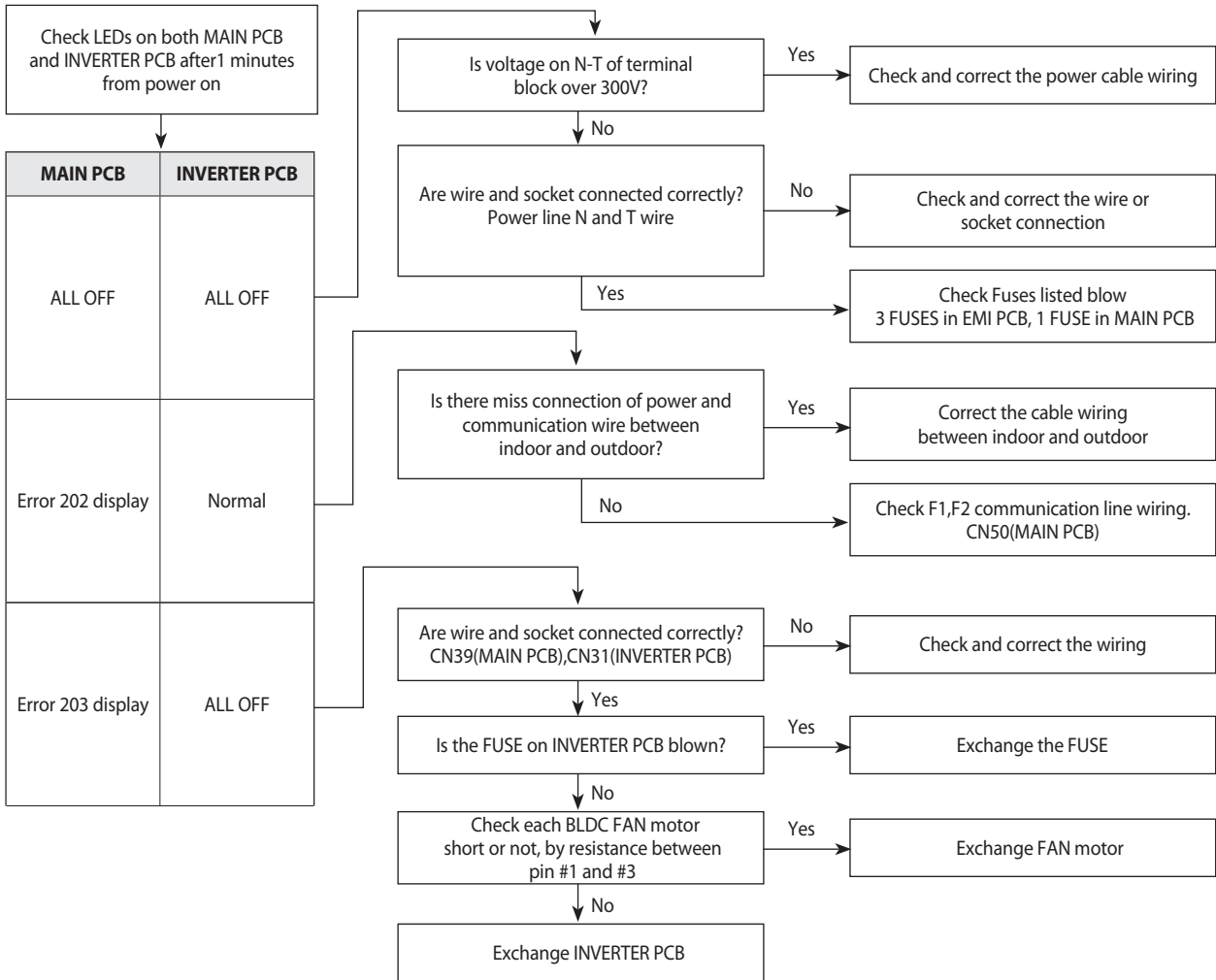

## 5. PCB Diagram

### 5-1 Control Kit

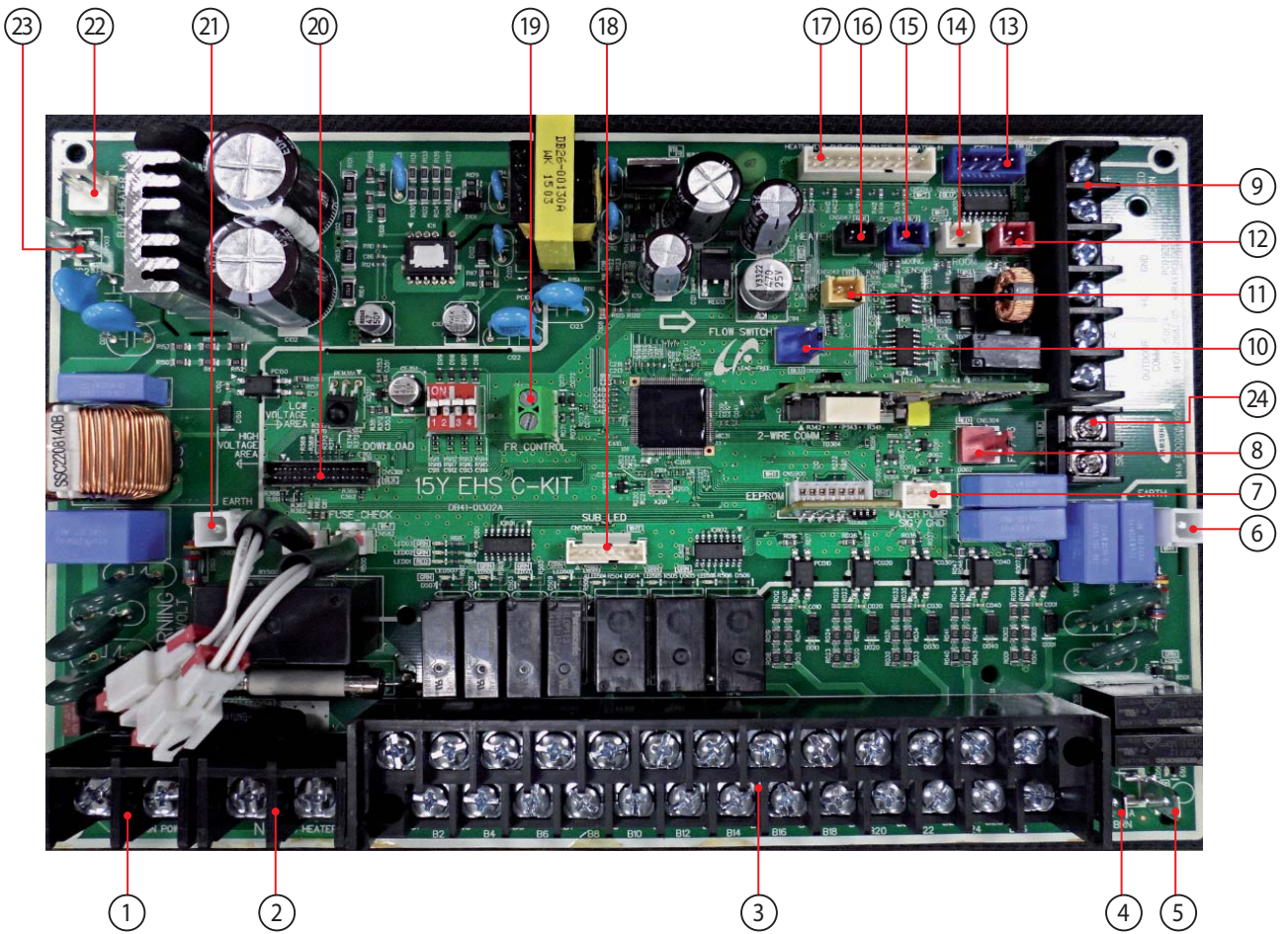

This Document can not be used without Samsung's authorization.

No.	Local	Function	Description
1	TB-A	MAIN POWER	DAPC 3013-2P BLK
2	TB-A1	BOOST HEATER	DAPC 3013-2P BLK
3	TB-B	EXTERNAL CONTROL	BR-1000C2-26P BLK
4	CNP001	MC2-A	YTR250
5	CNP002	MC1-A	YTR250
6	CN303	EARTH	YDW236-01 WHT
7	CNS1	WATER PUMP SIG/GND	SMW250-03 WHT
8	CNS304	WIRED REMOCON F3/F4	YW396-02V RED
9	TB-C	F1-F2/DC12V-GND/F3-F4	DAPC 2009-6P BLK
10	CNS041	FLOW SWITCH	YW396-02V BLU
11	CNS042	WATER TANK	SMW250-02 YEL
12	CNS046	SMART GRID	SMW250-02 RED
13	CNS062	EEV	SMW250-05 BLU
14	CNS044	ROOM	SMW250-02 WHT
15	CNS045	MIXING SENSOR	SMW250-02 BLU
16	CNS047	HEATER	SMW250-02 BLK
17	CNS043	HEATER/EVA-OUT/EVA-IN/WATER-OUT/WATER-IN	SMW250-10 WHT
18	CNS201	SUB_LED	SMW200-07 WHT
19	CNS2	FR_CONTROL	AKZ350 GRN
20	CNS301	DOWNLOAD	YDW200-20 BLK
21	CN101	EARTH	YDW236-01 WHT
22	CNP401	B/UP HEATER_N	YW396-02V WHT
23	CNP003	MC2-B	YTR250
24	CNS3	WATER PUMP SIG/GND	BR-7623C_2P



## 5-2 Outdoor Unit

### MAIN PCB

(AE090/120/140/160JXYDEH/EU, AE090/120/140/160JXYDGH/EU)

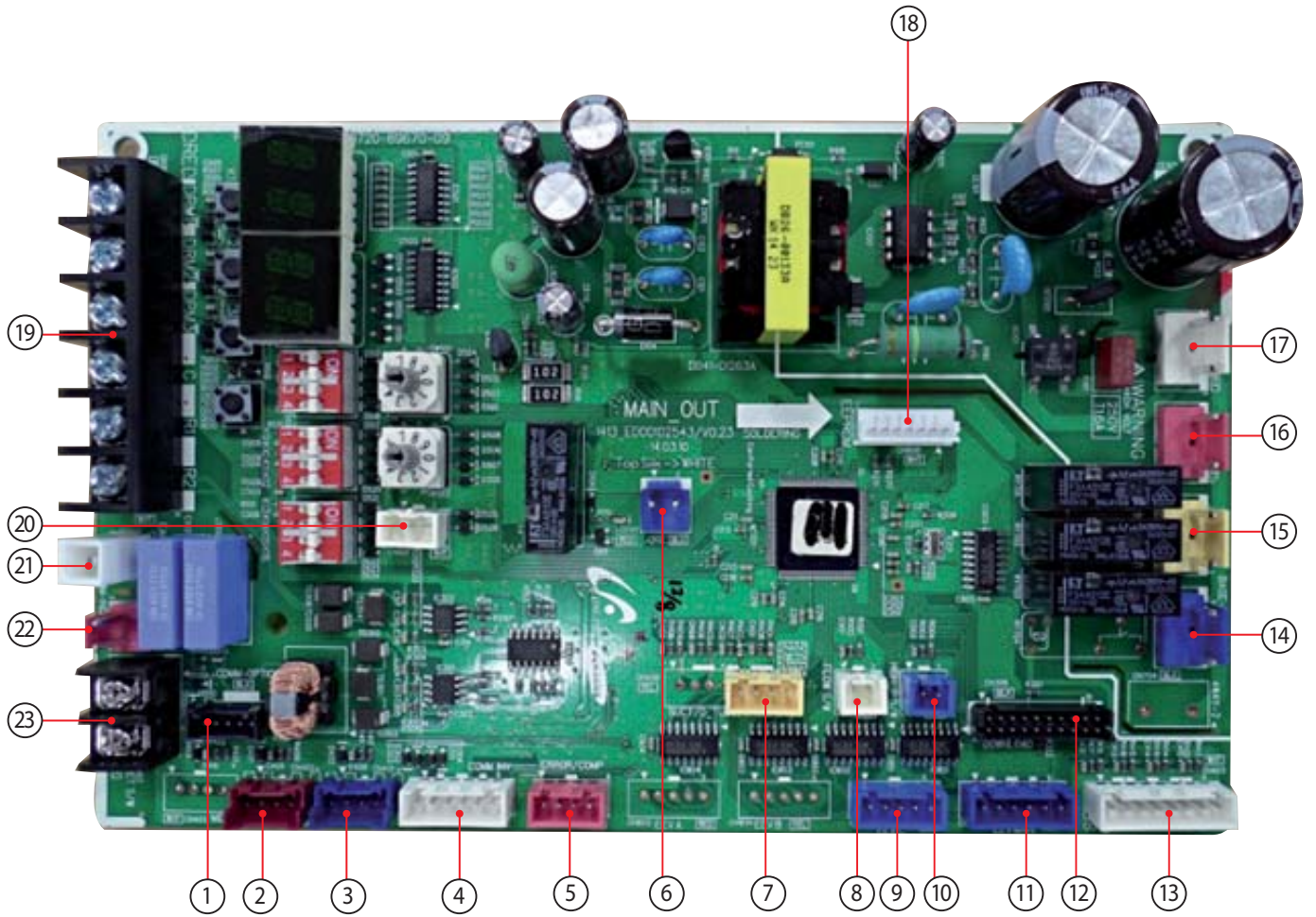

This Document can not be used without Samsung's authorization.

No.	Local	Function	Description
1	CN302	COMM-OPTION	SMW200-05 BLK
2	CN402	HIGH PRESSURE S/W	B04B-XARK-1 RED
3	CN401	LOW PRESSURE S/W	B04B-XARK-1 BLU
4	CN305	COMM INV	SMW250-06 WHT
5	CN801	ERROR/COMP CHECK	SMW250-04 RED
6	CN12	DC12V	YW396-02V BLU
7	CN407	WATER-IN/OUT	SMW250-04 YEL
8	CN001	EVA-IN	SMW250-02 WHT
9	CN803	EEV1	SMW250-05 BLU
10	CN407	HIGH_P S/W	SMW250-02 BLU
11	CN802	EEV4	SMW250-06 BLU
12	CN306	DOWNLOAD	YDW200-20P BLK
13	CN403	OUT TEMP/COND/DISQ/OLP	SMW250-08 WHT
14	CN703	BASE-HEATER	YW396-03AV BLU
15	CN702	4WAY-1	YW396-03AV YEL
16	CN701	HOTGAS	YW396-03AV RED
17	CN101	POWER	YW396-03AV WHT
18	CN806	EEPROM	B7P-MQ WHT
19	CN304	DRED	DAPC-2009-6P BLK
20	CN501	MODE SELECTOR	SMW250-03 WHT
21	CN103	EARTH	YDW236-01 WHT
22	CN303	COMM-INDOOR	YW396-02V RED
23	CN003	QUIET S/W	BR-7623-2P BLK

**INVERTER PCB**  
(AE090JXYDEH/EU)

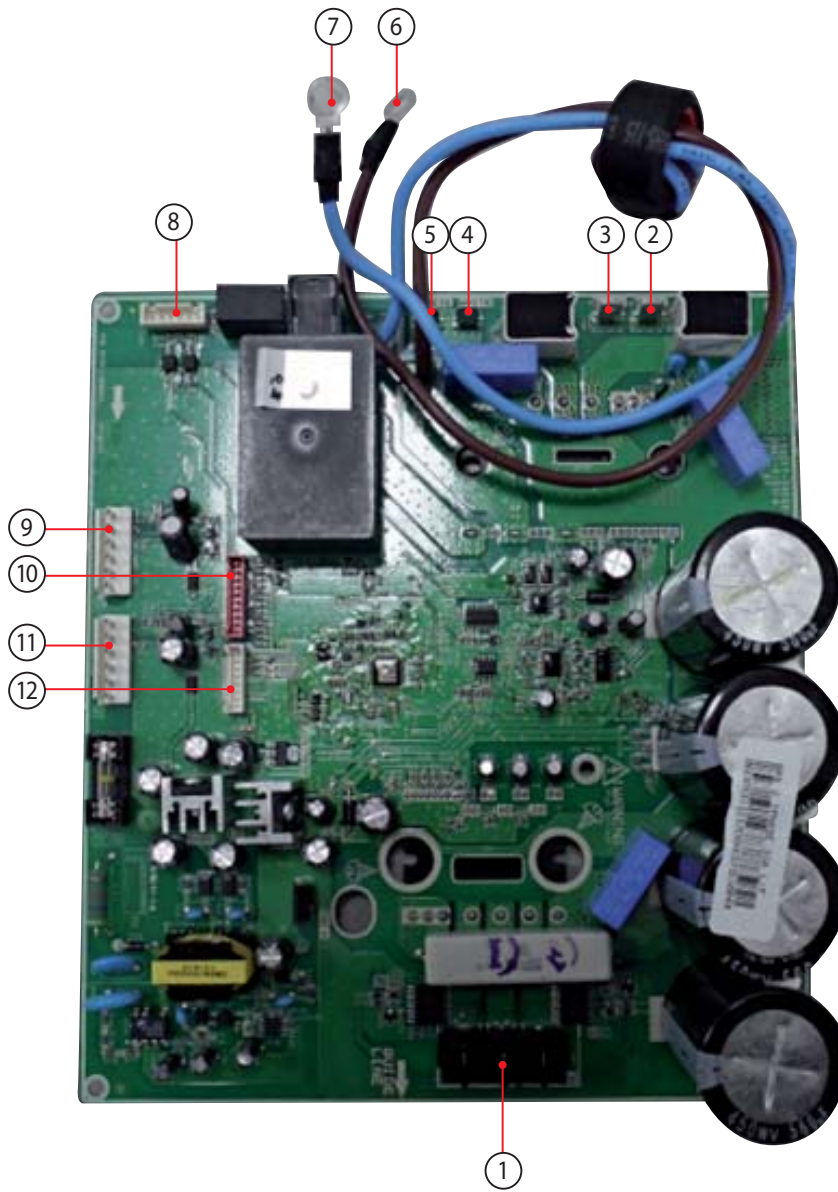

This Document can not be used without Samsung's authorization.

No.	Local	Function	Description
1	CN71	COMP	42819-3213 BLK
2	REACTOR-A2	REACTOR_A	YTR250
3	REACTOR-B2	REACTOR_B	YTR250
4	REACTOR-A1	REACTOR_A	YTR250
5	REACTOR-B1	REACTOR_B	YTR250
6	L	AC POWER	BRN WIRE
7	N	AC POWER	SKY/BLU WIRE
8	CN31	MAIN COMM	SMW250-06 WHT
9	CN91	BLDC FAN2	YW396-06V WHT
10	C22	DOWNLOADER	SMW200-10 RED
11	CN90	BLDC FAN1	YW396-06V WHT
12	CN21	DAC/ENCODER	SMW200-08 WHT

## INVERTER PCB (AE120/140/160JXYDEH/EU)

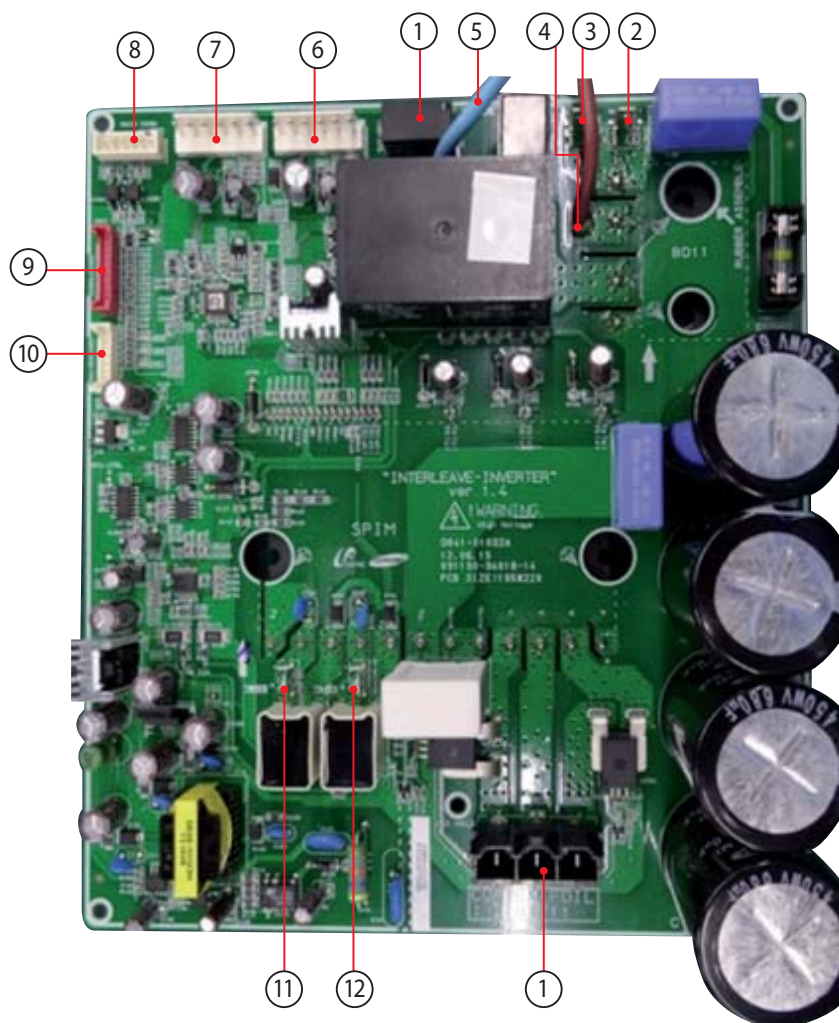

This Document can not be used without Samsung's authorization.

No.	Local	Function	Description
1	CN32	COMP	42819-3213 BLK
2	REACTOR-A1	REACTOR_A	YTR250
3	REACTOR-B1	REACTOR_B	YTR250
4	L	AC POWER	BRN WIRE
5	N	AC POWER	SKY/BLU WIRE
6	CN91	BLDC FAN2	YW396-06V WHT
7	CN90	BLDC FAN1	YW396-06V WHT
8	CN31	MAIN COMM	SMW250-06 WHT
9	C22	DOWNLOADER	SMW200-10 RED
10	CN21	DAC/ENCODER	SMW200-08 WHT
11	REACTOR-B2	REACTOR_B	YTR250
12	REACTOR-A2	REACTOR_A	YTR250

**INVERTER PCB**  
(AE090/120/140/160JXYDGH/EU)

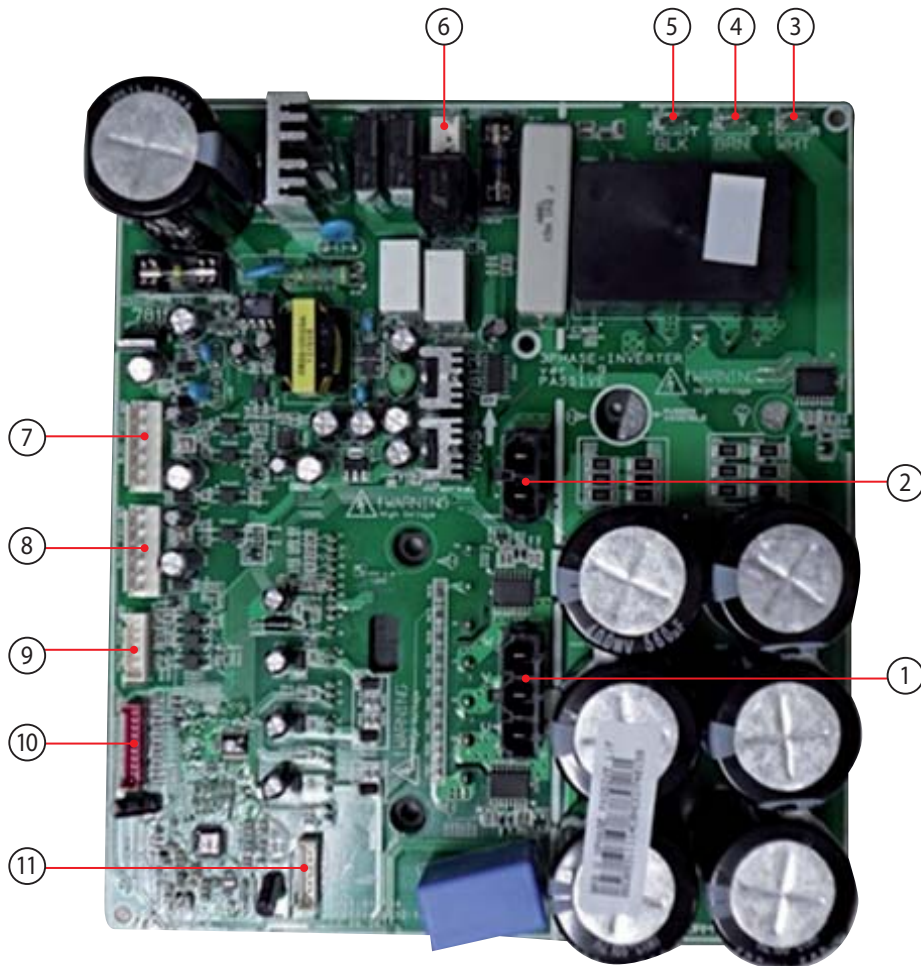

This Document can not be used without Samsung's authorization.

No.	Local	Function	Description
1	CN800	COMP	42819-3213 BLK
2	CN600	REACTOR	HLW1005-02 BLK
3	R	R-IN	YTR250
4	S	S-IN	YTR250
5	T	T-IN	YTR250
6	CN100	POWER	YW396-03AV WHT
7	CN91	BLDC FAN2	YW396-06V WHT
8	CN90	BLDC FAN1	YW396-06V WHT
9	CN31	MAIN COMM	SMW250-06 WHT
10	CN22	DOWNLOADER	SMW200-10 RED
11	CN21	DAC/ENCODER	SMW200-08 WHT

## EMI PCB (AE120/140/160JXYDEH/EU)

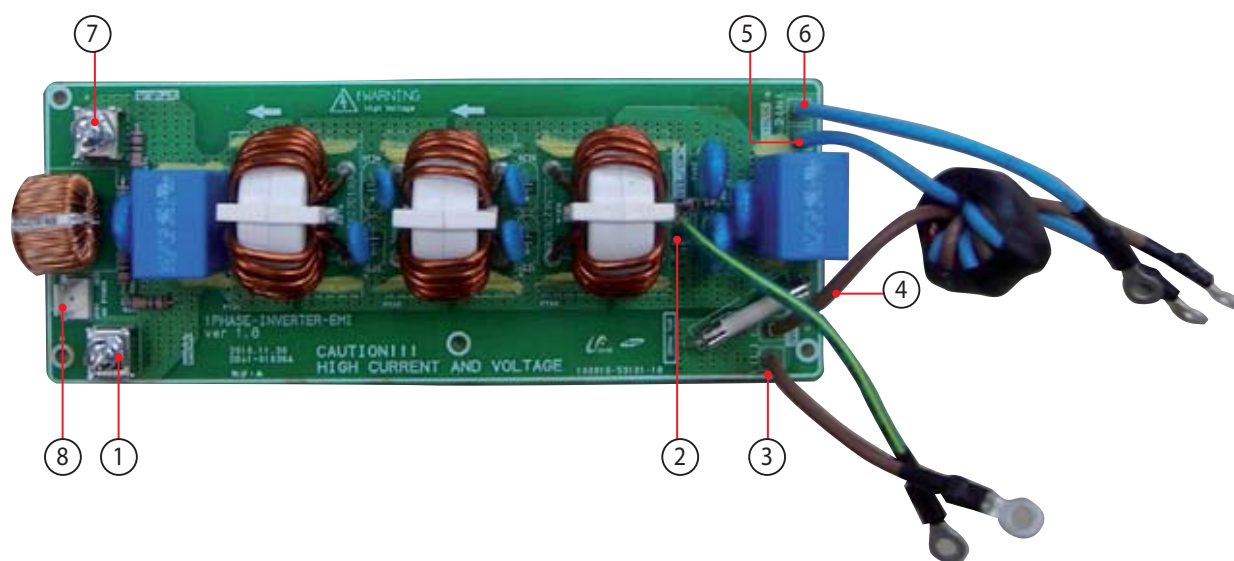

This Document can not be used without Samsung's authorization.

No.	Local	Function	Description
1	L1	POWER	OT-048
2	EARTH	EARTH	YEL/GRN WIRE
3	1(L)	POWER	BRN WIRE
4	L	POWER	BRN WIRE
5	N	POWER	SKY/BLU WIRE
6	2(N)	POWER	SKY/BLU WIRE
7	N1	POWER	OT-048
8	CN01	AC POWER	YW396-03AV WHT

**EMI PCB**  
(AE120/140/160JXYDGH/EU)

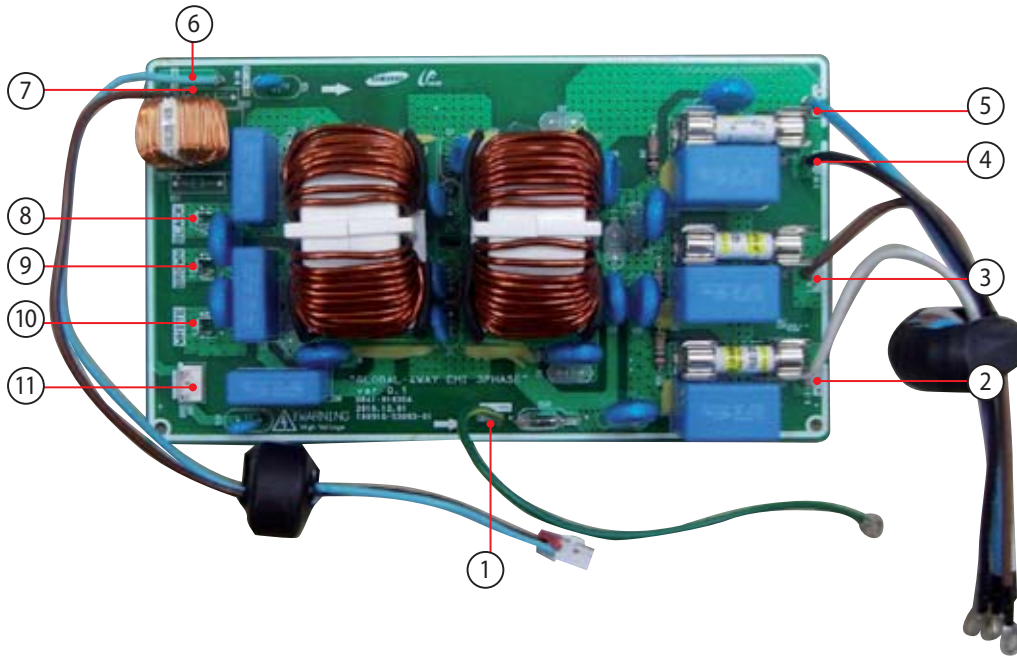

This Document can not be used without Samsung's authorization.

No.	Local	Function	Description
1	EARTH	EARTH	YEL/GRN WIRE
2	R-IN	POWER	WHT WIRE
3	S-IN	POWER	BRN WIRE
4	T-IN	POWER	BLK WIRE
5	N-IN	POWER	SKY/BLU WIRE
6	N-INV	POWER	SKY/BLU WIRE
7	T-INV	POWER	BRN WIRE
8	T-OUT	POWER	BLK WIRE
9	S-OUT	POWER	BRN WIRE
10	R-OUT	POWER	WHT WIRE
11	CN01	POWER	YW396-03AV WHT

## SUB-HEATER PCB

(AE090/120/140/160JXYDEH/EU, AE090/120/140/160JXYDGH/EU)

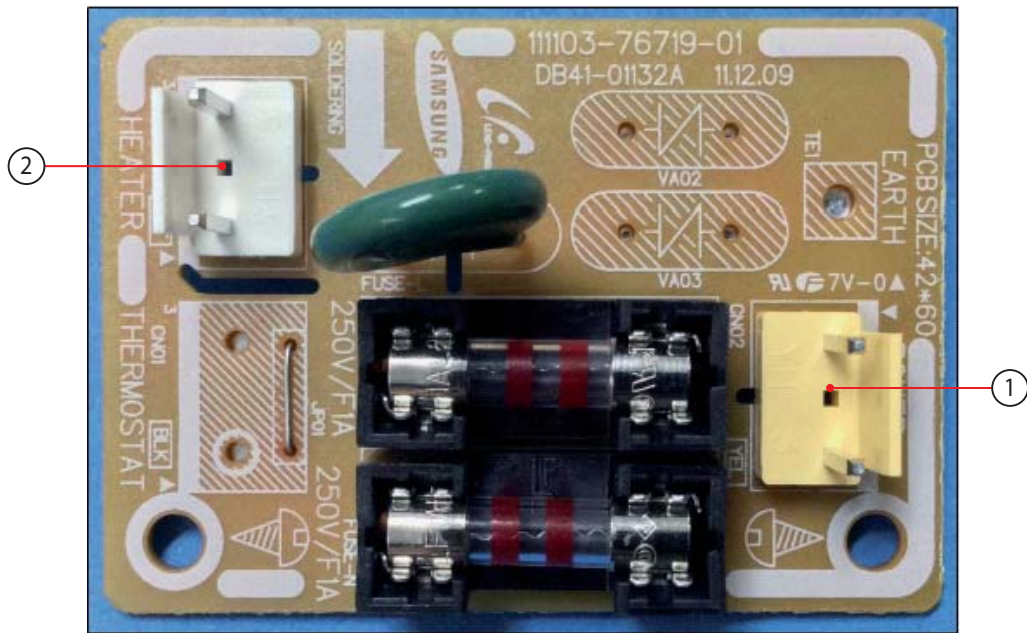

This Document can not be used without Samsung's authorization.

No.	Local	Function	Description
1	CN02	POWER	YW396-03AV YEL
2	CN03	HEATER	YW396-03AV WHT



# 6. Wiring Diagram

## 6-1 Control Kit

This Document can not be used without Samsung's authorization.

Resistance value of temperature sensor at 25°C(77°F)

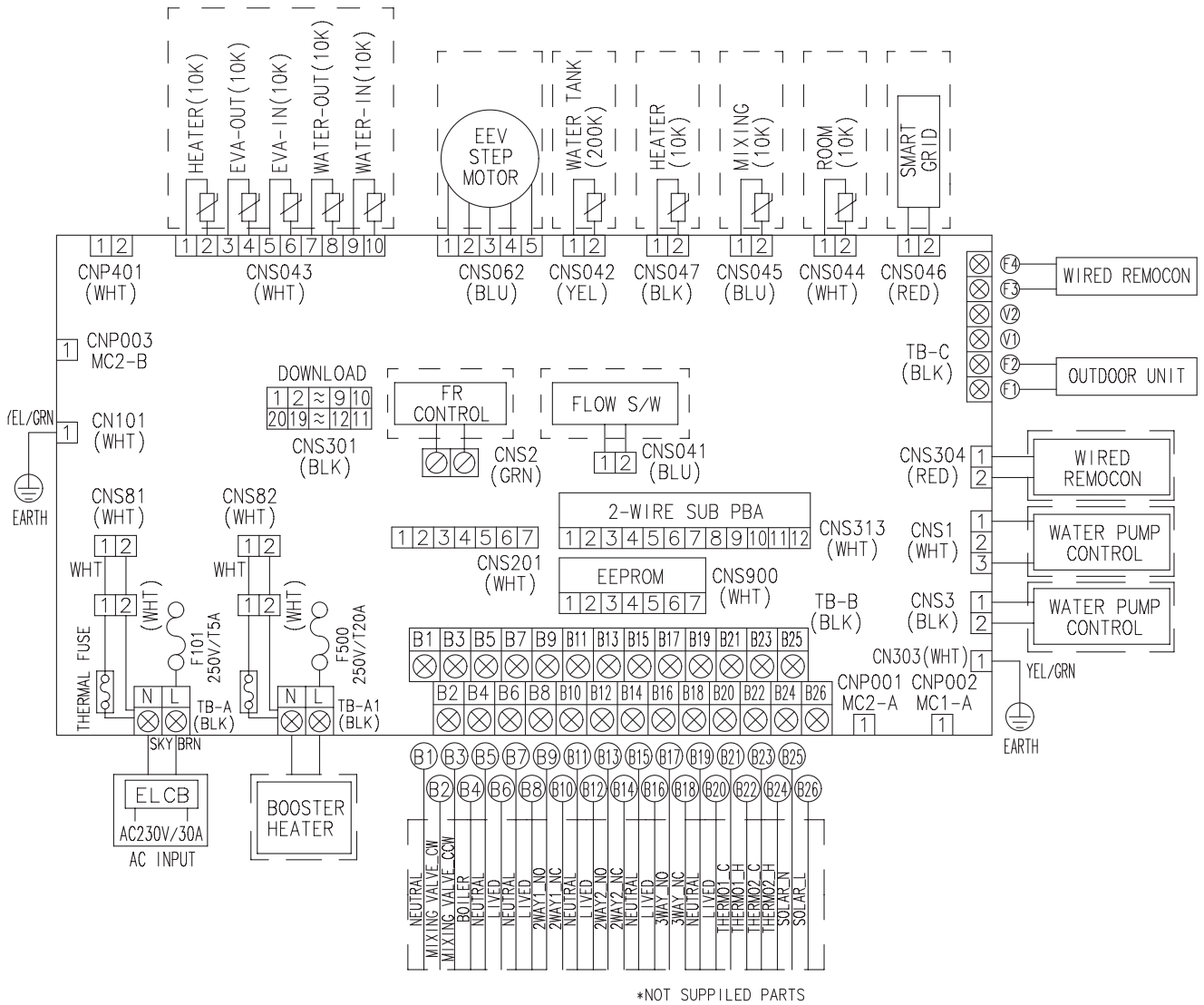

This Document can not be used without Samsung's authorization.





# 7. Reference Sheet

## 7-1 Index for Model Name

### 7-1-1 Outdoor Unit

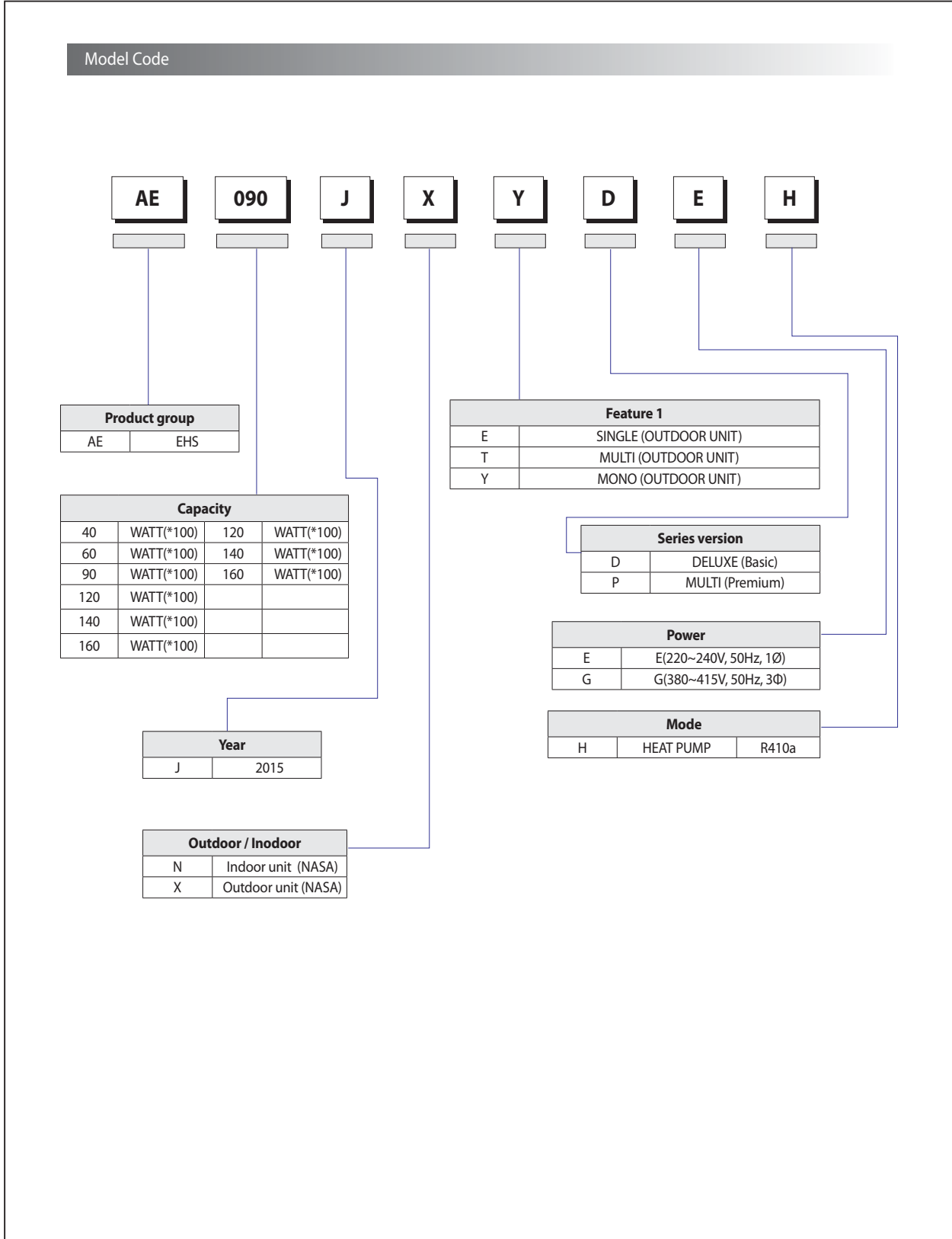

## 7-2 Refrigerant Circuit Diagram

This Document can not be used without Samsung's authorization.

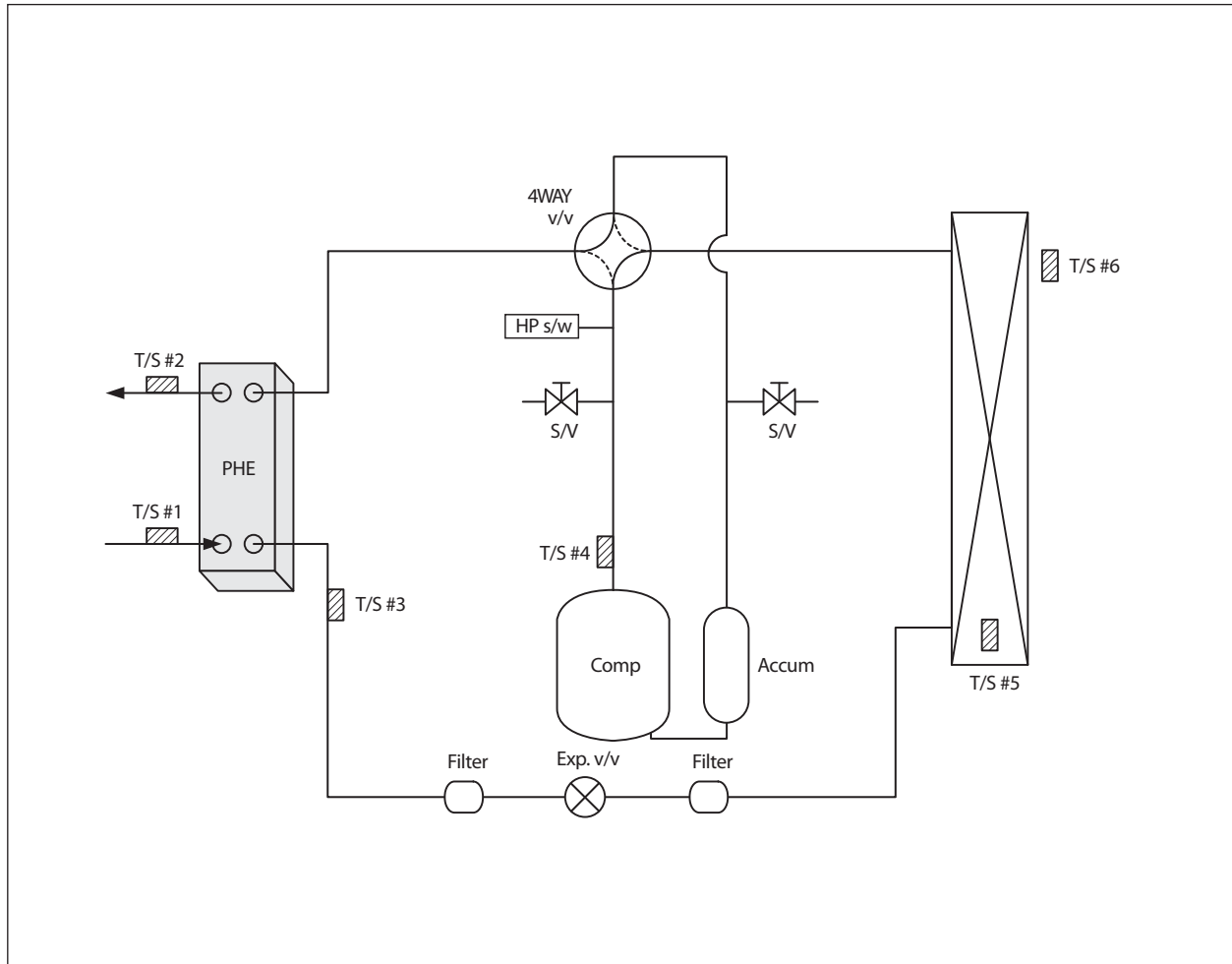

Part	Description
PHE	Plate heat exchanger
T/S #1	For water inlet temp sensor
T/S #2	For water outlet temp sensor
T/S #3	For PHE temp sensor
T/S #4	For discharge temp
T/S #5	For cond temp
T/S #6	For ambient temp sensor
S/V	Service valve ¼ inch
Accum	Accumulator
Exp. V/V	Expansion Valve
HP S/W	High Pressure Switch

# SAMSUNG

## **GSPN(Global Service Partner Network)**

Area	Web Site
Europe, CIS, Mideast & Africa	<a href="http://gspn1.samsungcsportal.com">gspn1.samsungcsportal.com</a>
Asia	<a href="http://gspn2.samsungcsportal.com">gspn2.samsungcsportal.com</a>
North & Latin America	<a href="http://gspn3.samsungcsportal.com">gspn3.samsungcsportal.com</a>
China	<a href="http://china.samsungportal.com">china.samsungportal.com</a>

This Service Manual is a property of Samsung Electronics Co., Ltd.  
Any unauthorized use of Manual can be punished under applicable  
International and/or domestic law.

© Samsung Electronics Co., Ltd. March. 2015.  
Printed in Korea.  
Code No. AC-00107E\_1