

※ History List

Version	Date	Update Information
1.0	'15.03.30	- 2015 New EHS Mono TDB Released. (Except SCOP / ESEER)
1.1	'15.04.06	- Add SCOP / ESEER
1.2	'15.04.10	- Modify Capacity Table
1.3	'15.06.19	- Add 5kW Model / Control KIT (E03BN) - Modify : Change the Note for Refrigerant
1.4	'15.06.22	- Modify Product Gross for 5kW Model - Modify : Piping Diagram / Operating Range for DHW
1.5	'16.04.11	- Modify : Nominal Capacity / Power Input / Power Current / Shipping Size Heating Capacity Table (Peak & Integrated) / Outdoor Unit Drawing

EHS

Technical Data Book

EHS Mono for Europe

(R410A, 50Hz, H/P)

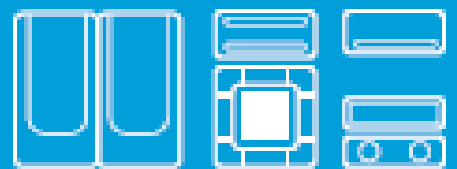

Model : AE***JXYDEH/EU
AE***JXYDGH/EU

SAMSUNG

++++ Contents



I. Products

- 1. Nomenclature**
- 2. Line-up**

II. Specifications

- 1. Specification**
- 2. Capacity Tables**
- 3. Dimensional Drawings**
- 4. Piping Diagrams**
- 5. Wiring Diagrams**
- 6. Electric Specifications**
- 7. Sound Pressure Level**
- 8. Operation Range**
- 9. Hydraulic Performance**

III. Application

- 1. Application Example**

I. Products

1. Nomenclature

2. Line-up

1. Nomenclature

1-1. Outdoor Unit









Model Name (New)

AE	090	J	X	Y	D	E	H	/	EU
(1)	(2)	(3)	(4)	(5)	(6)	(7)	(8)		(Buyer)

(1) Classification		(5) Type	
AE	EHS	Y	Mono (Outdoor Unit)
(2) Capacity		(6) Feature 1	
x 1/10 kW (3 digits)		D	DELUXE (Basic)
(3) Version		(7) Rating Voltage	
J	2015	E	1Φ, 220~240V, 50Hz
(4) Product Type		G	3Φ, 380~415V, 50Hz
N	Indoor	(8) Mode	
X	Outdoor	H	Heat Pump
			R410A

2. Line-up

2-1. Outdoor Unit

Mono Type	Capacity (kW)				
	5.0	9.0	12.0	14.0	16.0
1 Phase	 AE050JXYDEH	 AE090JXYDEH	 AE120JXYDEH	 AE140JXYDEH	 AE160JXYDEH
3 Phases	N/A	 AE090JXYDGH	 AE120JXYDGH	 AE140JXYDGH	 AE160JXYDGH

2-2. Control Kit

Control Unit
 MIM-E03A(B)N

II. Specifications

1. Specifications
2. Capacity Tables
3. Dimensional Drawings
4. Piping Diagrams
5. Wiring Diagrams
6. Electric Specifications
7. Sound Pressure Level
8. Operation Range
9. Hydraulic Performance

1. Specifications

1-1. Outdoor Unit

Type				Mono	Mono	Mono		
Model Name	Outdoor Unit			AE050JXYDEH/EU	AE090JXYDEH/EU	AE120JXYDEH/EU		
System	Mode			-	Heat Pump (A2W)	Heat Pump (A2W)	Heat Pump (A2W)	
	Performance (A7/W35) ^{*1}	Nominal Capacity (Min/Std/Max)	Heating	kW	1.667 / 5.00 / 5.00	2.20 / 9.00 / 9.00	3.75 / 12.00 / 12.00	
				Btu/h	5,700 / 17,100 / 17,100	7,500 / 30,700 / 30,700	12,800 / 40,900 / 40,900	
			Cooling	kW	1.625 / 5.00 / 5.00	1.75 / 7.50 / 7.50	3.30 / 12.00 / 12.00	
				Btu/h	5,500 / 17,100 / 17,100	6,000 / 25,600 / 25,600	11,300 / 40,900 / 40,900	
		Power Input (Nominal) (Min/Std/Max)	Heating	kW	0.348 / 1.06 / 1.06	0.49 / 2.14 / 2.14	0.809 / 2.66 / 2.66	
					Cooling	0.438 / 1.21 / 1.21	0.48 / 1.95 / 1.95	0.853 / 3.16 / 3.16
		Current Input (Nominal) (Min/Std/Max)	Heating	A	1.6 / 5.1 / 5.1	2.3 / 9.2 / 9.2	3.7 / 12.0 / 12.0	
					Cooling	2.0 / 5.7 / 5.7	2.2 / 9.0 / 9.0	3.9 / 14.3 / 14.3
		COP (Nominal Heating)			4.72	4.21	4.51	
		EER (Nominal Cooling)			4.13	3.85	3.80	
	SCOP(35°C)			4.50	4.41	4.46		
	ESEER			5.29	5.07	4.98		
	Performance (A2/W35) ^{*2}	Capacity	Heating	W	4,500	7,000	9,800	
		COP			3.46	3.00	3.32	
	Performance (A-7/W35) ^{*3}	Capacity	Heating	W	4,700	7,600	10,300	
		COP			2.69	2.39	2.61	
	Field Wiring	MCA		A	20	22	28	
		MFA		A	25	27.5	35	
	Water Connections	Water Flow Rate (Heating/Cooling)		LPM	14.5/14.5	26/22	35/35	
		Water Pressure (Max)		bar	3	3	3	
		Water Pipe	Inlet	Φ, inch	BSP male 1"	BSP male 1"	BSP male 1"	
			Outlet	Φ, inch	BSP male 1"	BSP male 1"	BSP male 1"	
		Leaving Water Temperature	Heating	°C	25~55	25~55	25~55	
	Cooling		°C	5~25	5~25	5~25		
	Refrigerant	Type			R410A	R410A	R410A	
		Control Method			EEV INCLUDED	EEV INCLUDED	EEV INCLUDED	
		Factory Charging		g	1,150	1,400	2,600	
	Outdoor Unit	Power Supply			V, Hz, Φ	220~240V, 50Hz, 1Φ	220~240V, 50Hz, 1Φ	220~240V, 50Hz, 1Φ
		Compressor	Type			BLDC Twin Rotary	BLDC Twin Rotary	BLDC Twin Rotary
Model				UG4TH200FUAE4	UG8TH8265FJW	UG5T450FU		
Oil				POE	POE	PVE		
Fan		Air Flow Rate	Cooling	CMM	51	66	99	
				l/s	850	1100	1650	
Number of Unit			EA	1	1	2		
Base Heater			W	N/A	150	150		
Sound ^{*4}		Sound Pressure	Heating	dB(A)	45	48	50	
			Cooling	dB(A)	45	48	50	
		Sound Power	Heating	dB	61	63	64	
			Cooling	dB	62	64	65	
External Dimension		Net Weight		kg	59.0	76.0	108.0	
		Shipping Weight		kg	63.0	84.0	118.0	
		Net Dimensions (WxHxD)		mm	880 x 798 x 310	940 x 998 x 330	940 x 1,420 x 330	
		Shipping Dimensions (WxHxD)		mm	1023 x 937 x 413	995 x 1,178 x 426	995 x 1,598 x 426	
Operating Temp. Range		Heating ^{*5}		°C	-25~35	-25~35	-25~35	
	Cooling		°C	10~46	10~46	10~46		
	DHW Tank ^{*6}		°C	-25~43	-25~43	-25~43		

*1) A2W Condition #1 : (Heating) Water In/Out 30°C/35°C, Outdoor Air DB/WB 7°C/6°C; (Cooling) Water In/Out 23°C/18°C, Outdoor Air DB 35°C.

*2) A2W Condition #2 : (Heating) Water In/Out *35°C, Outdoor Air DB/WB 2°C/1°C

*3) A2W Condition #3 : (Heating) Water In/Out *35°C, Outdoor Air DB/WB -7°C/-8°C

*4) Sound Pressure was acquired in an anechoic room. Thus actual noise level may be different depending on the installation conditions.

*5) At the temperature -25°C ~ -20°C, operation is available but capacity cannot be guaranteed.

*6) Heat pump operating range of DHW : -25°C ~ 35°C.

7) These products contain R410A which is fluorinated greenhouse gas.

1. Specifications

1-1. Outdoor Unit

Type				Mono	Mono	Mono	
Model Name		Outdoor Unit		AE140JXYDEH/EU	AE160JXYDEH/EU	AE090JXYDGH/EU	
System	Mode			-	Heat Pump (A2W)	Heat Pump (A2W)	Heat Pump (A2W)
	Performance (A7/W35) ^{*1}	Nominal Capacity (Min/Std/Max)	Heating	kW	3.75 / 14.00 / 14.00	3.75 / 16.00 / 16.00	2.20 / 9.00 / 9.00
				Btu/h	12,800 / 47,800 / 47,800	12,800 / 54,600 / 54,600	7,500 / 30,700 / 30,700
			Cooling	kW	3.30 / 13.00 / 13.00	3.30 / 14.00 / 14.00	1.75 / 7.00 / 7.00
				Btu/h	11,300 / 44,400 / 44,400	11,300 / 47,800 / 47,800	6,000 / 23,900 / 23,900
		Power Input (Nominal) (Min/Std/Max)	Heating	kW	0.809 / 3.14 / 3.14	0.809 / 3.80 / 3.80	0.49 / 2.14 / 2.14
					Cooling	0.853 / 3.50 / 3.50	0.853 / 3.84 / 3.84
		Current Input (Nominal) (Min/Std/Max)	Heating	A	3.7 / 14.3 / 14.3	3.7 / 17.1 / 17.1	0.8 / 3.5 / 3.5
					Cooling	3.9 / 15.7 / 15.7	3.9 / 17.3 / 17.3
		COP (Nominal Heating)			4.46	4.21	4.21
		EER (Nominal Cooling)			3.71	3.65	3.65
	SCOP(35°C)			4.43	4.41	4.41	
	ESEER			4.97	4.92	4.69	
	Performance (A2/W35) ^{*2}	Capacity	Heating	W	11,200	12,500	7,000
		COP			3.26	3.10	3.00
	Performance (A-7/W35) ^{*3}	Capacity	Heating	W	10,800	13,400	7,600
		COP			2.56	2.47	2.39
	Field Wiring	MCA		A	30	32	10
		MFA		A	37.5	40	16.1
	Water Connections	Water Flow Rate (Heating/Cooling)		LPM	40/37	46/40	26/21
		Water Pressure (Max)		bar	3	3	3
		Water Pipe	Inlet	Φ, inch	BSP male 1"	BSP male 1"	BSP male 1"
			Outlet	Φ, inch	BSP male 1"	BSP male 1"	BSP male 1"
		Leaving Water Temperature	Heating	°C	25~55	25~55	25~55
	Cooling		°C	5~25	5~25	5~25	
	Refrigerant	Type			R410A	R410A	R410A
		Control Method			EEV INCLUDED	EEV INCLUDED	EEV INCLUDED
		Factory Charging		g	2,600	2,600	1,500
Outdoor Unit	Power Supply			V, Hz, Φ	220~240V, 50Hz, 1Φ	220~240V, 50Hz, 1Φ	380~415V, 50Hz, 3Φ
	Compressor	Type			BLDC Twin Rotary	BLDC Twin Rotary	BLDC Twin Rotary
		Model			UG5T450FU	UG5T450FU	UG8T300FUCJU
		Oil			PVE	PVE	PVE
	Fan	Air Flow Rate	Cooling	CMM	108	118	66
				l/s	1800	1967	1100
	Number of Unit			EA	2	2	1
	Base Heater			W	150	150	150
	Sound ^{*4}	Sound Pressure	Heating	dB(A)	51	52	48
			Cooling	dB(A)	52	54	48
		Sound Power	Heating	dB	65	66	63
			Cooling	dB	66	69	64
	External Dimension	Net Weight		kg	108.0	108.0	76.0
		Shipping Weight		kg	118.0	118.0	84.0
		Net Dimensions (WxHxD)		mm	940 x 1,420 x 330	940 x 1,420 x 330	940 x 998 x 330
		Shipping Dimensions (WxHxD)		mm	995 x 1,598 x 426	995 x 1,598 x 426	995 x 1,178 x 426
	Operating Temp. Range	Heating ^{*5}		°C	-25~35	-25~35	-25~35
		Cooling		°C	10~46	10~46	10~46
		DHW Tank ^{*6}		°C	-25~43	-25~43	-25~43

*1) A2W Condition #1 : (Heating) Water In/Out 30°C/35°C, Outdoor Air DB/WB 7°C/6°C; (Cooling) Water In/Out 23°C/18°C, Outdoor Air DB 35°C.

*2) A2W Condition #2 : (Heating) Water In/Out *35°C, Outdoor Air DB/WB 2°C/1°C

*3) A2W Condition #3 : (Heating) Water In/Out *35°C, Outdoor Air DB/WB -7°C/-8°C

*4) Sound Pressure was acquired in an anechoic room. Thus actual noise level may be different depending on the installation conditions.

*5) At the temperature -25°C ~ -20°C, operation is available but capacity cannot be guaranteed.

*6) Heat pump operating range of DHW : -25°C ~ 35°C.

7) These products contain R410A which is fluorinated greenhouse gas.

1. Specifications

1-1. Outdoor Unit

Type				Mono	Mono	Mono	
Model Name		Outdoor Unit		AE120JXYDGH/EU	AE140JXYDGH/EU	AE160JXYDGH/EU	
System	Mode		-	Heat Pump (A2W)	Heat Pump (A2W)	Heat Pump (A2W)	
	Performance (A7/W35) ^{*1}	Nominal Capacity (Min/Std/Max)	Heating	kW	3.75 / 12.00 / 12.00	3.75 / 14.00 / 14.00	3.75 / 16.00 / 16.00
				Btu/h	12,800 / 40,900 / 40,900	12,800 / 47,800 / 47,800	12,800 / 54,600 / 54,600
			Cooling	kW	3.30 / 12.00 / 12.00	3.30 / 13.00 / 13.00	3.30 / 14.00 / 14.00
				Btu/h	11,300 / 40,900 / 40,900	11,300 / 44,400 / 44,400	11,300 / 47,800 / 47,800
		Power Input (Nominal) (Min/Std/Max)	Heating	kW	0.809 / 2.66 / 2.66	0.809 / 3.14 / 3.14	0.809 / 3.80 / 3.80
					Cooling	0.853 / 3.16 / 3.16	0.853 / 3.50 / 3.50
		Current Input (Nominal) (Min/Std/Max)	Heating	A	1.3 / 4.2 / 4.2	1.3 / 4.8 / 4.8	1.3 / 5.7 / 5.7
					Cooling	1.3 / 5.2 / 5.2	1.3 / 5.3 / 5.3
		COP (Nominal Heating)			4.51	4.46	4.21
		EER (Nominal Cooling)			3.80	3.71	3.65
	SCOP(35°C)			4.46	4.43	4.41	
	ESEER			4.98	4.97	4.92	
	Performance (A2/W35) ^{*2}	Capacity	Heating	W	9,800	11,200	12,500
		COP			3.32	3.26	3.10
	Performance (A-7/W35) ^{*3}	Capacity	Heating	W	10,300	10,800	13,400
		COP			2.61	2.56	2.47
	Field Wiring	MCA		A	10	12	12
		MFA		A	16.1	16.1	16.1
	Water Connections	Water Flow Rate (Heating/Cooling)		LPM	35/35	40/37	46/40
		Water Pressure (Max)		bar	3	3	3
		Water Pipe	Inlet	Φ, inch	BSP male 1"	BSP male 1"	BSP male 1"
			Outlet	Φ, inch	BSP male 1"	BSP male 1"	BSP male 1"
		Leaving Water Temperature	Heating	°C	25~55	25~55	25~55
	Cooling		°C	5~25	5~25	5~25	
	Refrigerant	Type			R410A	R410A	R410A
		Control Method			EEV INCLUDED	EEV INCLUDED	EEV INCLUDED
		Factory Charging		g	2,600	2,600	2,600
Power Supply			V, Hz, Φ	380~415V, 50Hz, 3Φ	380~415V, 50Hz, 3Φ	380~415V, 50Hz, 3Φ	
Compressor	Type			BLDC Twin Rotary	BLDC Twin Rotary	BLDC Twin Rotary	
	Model			UG5T450FU	UG5T450FU	UG5T450FU	
	Oil			PVE	PVE	PVE	
Fan	Air Flow Rate	Cooling	CMM	99	108	118	
			l/s	1650	1800	1967	
Number of Unit			EA	2	2	2	
Base Heater			W	150	150	150	
Sound ^{*4}	Sound Pressure	Heating	dB(A)	50	51	52	
		Cooling	dB(A)	50	52	54	
	Sound Power	Heating	dB	64	65	66	
		Cooling	dB	65	66	69	
External Dimension	Net Weight		kg	108.0	108.0	108.0	
	Shipping Weight		kg	118.0	118.0	118.0	
	Net Dimensions (WxHxD)		mm	940 x 1,420 x 330	940 x 1,420 x 330	940 x 1,420 x 330	
	Shipping Dimensions (WxHxD)		mm	995 x 1,598 x 426	995 x 1,598 x 426	995 x 1,598 x 426	
Operating Temp. Range	Heating ^{*5}		°C	-25~35	-25~35	-25~35	
	Cooling		°C	10~46	10~46	10~46	
	DHW Tank ^{*6}		°C	-25~43	-25~43	-25~43	

*1) A2W Condition #1 : (Heating) Water In/Out 30°C/35°C, Outdoor Air DB/WB 7°C/6°C; (Cooling) Water In/Out 23°C/18°C, Outdoor Air DB 35°C.

*2) A2W Condition #2 : (Heating) Water In/Out */35°C, Outdoor Air DB/WB 2°C/1°C

*3) A2W Condition #3 : (Heating) Water In/Out */35°C, Outdoor Air DB/WB -7°C/-8°C

*4) Sound Pressure was acquired in an anechoic room. Thus actual noise level may be different depending on the installation conditions.

*5) At the temperature -25°C ~ -20°C, operation is available but capacity cannot be guaranteed.

*6) Heat pump operating range of DHW : -25°C ~ 35°C.

7) These products contain R410A which is fluorinated greenhouse gas.

1. Specifications

1-2. Control Kit

Model Name			MIM-E03AN	MIM-E03BN
Use with		-	090/120/140/160 Model	050 Model
Power Supply		V, Hz, Φ	220~240V, 50Hz, 1 Φ	220~240V, 50Hz, 1 Φ
External Dimension	Weight	Net	kg	3.5
		Gross	kg	6.0
	Dimensions (WxHxD)	Net	mm	370x110x290
		Gross	mm	439x168x329
Flow Switch	Set Point (Min. flow rates)	LPM	16 \pm 1.5	7 \pm 1.5
External Control	Booster Heater		AC 230V (Max 20A)	AC 230V (Max 20A)
	Back up Heater (/Boiler)		AC 230V (Max 0.5A)	AC 230V (Max 0.5A)
	Water Pump		AC 230V (Max 2A)	AC 230V (Max 2A)
	2way(or 3way) Valve		AC 230V (Max 0.5A / 120W)	AC 230V (Max 0.5A / 120W)
	Room Thermostat		AC 230V (Max 10mA)	AC 230V (Max 10mA)
	Solar Pump		AC 230V (Max 10mA)	AC 230V (Max 10mA)
	Inverter Pump		AC 230V (Max 2A) (NEW)	AC 230V (Max 2A)
3way Mixing Valve		AC 230V (Max 0.5A / 120W) (NEW)	AC 230V (Max 0.5A / 120W)	

2. Capacity Tables

2-1. AE050/090/120/140/160JXYDEH/EU (1 Phase)

1) Maximum Heating Capacity (Peak Value)

LWT (Leaving Water Temp.), Tamb (Ambient Temp.), HC (Heating Capacity), PI (Power input)

	LWE(°C)	30		35		40		45		50		55	
	Tamb(°C)	HC(kW)	PI(kW)	HC(kW)	PI(kW)	HC(kW)	PI(kW)	HC(kW)	PI(kW)	HC(kW)	PI(kW)	HC(kW)	PI(kW)
AE050JXYDEH/EU	-20	3.57	1.47	3.40	1.65	3.38	1.75	3.36	2.06				
	-15	4.52	1.69	4.30	1.90	4.13	2.00	3.95	2.10	3.83	2.21		
	-10	5.25	1.78	5.00	2.00	4.85	2.10	4.70	2.21	4.56	2.32	4.23	2.54
	-7	5.14	1.62	4.90	1.82	4.79	2.06	4.69	2.29	4.79	2.50	4.90	2.71
	-2	5.49	1.54	5.23	1.73	5.03	1.90	4.83	2.07	4.59	2.33	4.35	2.59
	2	5.49	1.35	5.23	1.51	4.94	1.60	4.65	1.69	4.42	1.90	4.19	2.11
	7	5.25	0.94	5.00	1.06	4.85	1.21	4.70	1.35	4.60	1.48	4.50	1.60
	10	5.73	0.95	5.46	1.07	5.32	1.22	5.18	1.36	4.93	1.53	4.67	1.70
	15	6.54	0.97	6.23	1.08	6.11	1.21	5.99	1.38	5.69	1.55	5.39	1.73
	20	7.35	0.98	7.00	1.10	6.90	1.24	6.80	1.40	6.46	1.58	6.12	1.75
AE090JXYDEH/EU	-20	6.30	2.67	6.00	3.00	5.85	3.20	5.70	3.53				
	-15	7.46	2.85	7.10	3.20	6.90	3.40	6.70	3.60	6.50	3.78		
	-10	9.03	3.03	8.60	3.40	8.34	3.59	8.08	3.78	7.84	3.97	7.28	4.35
	-7	8.31	2.95	7.92	3.31	7.68	3.48	7.45	3.65	6.80	3.75	6.15	3.85
	-2	8.71	2.79	8.30	3.13	8.03	3.30	7.76	3.47	7.37	3.90	6.98	4.33
	2	8.55	2.41	8.14	2.71	7.85	2.87	7.56	3.02	7.18	3.40	6.80	3.78
	7	9.45	1.90	9.00	2.14	8.55	2.27	8.10	2.39	8.05	2.68	8.00	2.96
	10	10.38	1.90	9.89	2.14	9.47	2.29	9.06	2.44	8.61	2.75	8.15	3.05
	15	11.93	1.89	11.36	2.13	11.01	2.29	10.66	2.53	10.13	2.85	9.59	3.16
	20	13.48	1.89	12.84	2.12	12.55	2.35	12.26	2.62	11.65	2.95	11.03	3.27
AE120JXYDEH/EU	-20	9.82	4.09	9.35	4.60	8.93	4.90	8.50	5.29				
	-15	11.13	4.27	10.60	4.80	10.30	5.10	10.00	5.40	9.70	5.67		
	-10	12.39	4.09	11.80	4.60	11.45	5.14	11.09	5.67	10.76	5.95	9.98	6.52
	-7	11.27	3.66	10.73	4.11	10.26	4.52	9.78	4.93	9.30	5.33	8.82	5.74
	-2	11.99	3.49	11.42	3.92	11.22	4.38	11.02	4.85	10.47	5.45	9.92	6.06
	2	11.97	3.05	11.40	3.43	11.51	3.92	11.63	4.42	11.05	4.97	10.47	5.52
	7	12.60	2.37	12.00	2.66	11.70	3.06	11.40	3.45	10.95	3.68	10.50	3.90
	10	13.91	2.35	13.25	2.64	12.89	3.02	12.54	3.40	11.91	3.83	11.28	4.25
	15	16.09	2.31	15.32	2.60	14.88	2.92	14.43	3.33	13.71	3.74	12.98	4.16
	20	18.27	2.28	17.40	2.56	16.86	2.88	16.32	3.25	15.50	3.66	14.69	4.06
AE140JXYDEH/EU	-20	10.13	4.36	9.65	4.90	9.33	5.20	9.01	5.59				
	-15	11.76	4.54	11.20	5.10	10.90	5.40	10.60	5.70	10.28	5.99		
	-10	13.44	4.63	12.80	5.20	12.42	5.59	12.03	5.99	11.67	6.28	10.83	6.88
	-7	11.81	3.91	11.25	4.40	11.20	5.14	11.15	5.89	10.78	6.02	10.42	6.15
	-2	13.13	3.87	12.50	4.35	12.46	5.06	12.41	5.77	11.79	6.49	11.17	7.21
	2	13.67	3.56	13.02	4.00	12.99	4.62	12.97	5.23	12.32	5.89	11.67	6.54
	7	14.70	2.79	14.00	3.14	13.50	3.55	13.00	3.95	12.63	4.20	12.25	4.45
	10	15.67	2.79	14.92	3.13	14.42	3.52	13.92	3.90	13.23	4.39	12.53	4.87
	15	17.28	2.77	16.46	3.12	15.96	3.41	15.46	3.81	14.69	4.29	13.92	4.77
	20	18.90	2.76	18.00	3.10	17.50	3.38	17.00	3.73	16.15	4.20	15.30	4.66
AE160JXYDEH/EU	-20	11.87	5.30	11.30	5.95	10.75	6.25	10.20	6.76				
	-15	13.65	5.61	13.00	6.30	12.50	6.60	12.00	6.90	11.64	7.25		
	-10	15.12	5.43	14.40	6.10	13.97	6.67	13.54	7.25	13.13	7.61	12.18	8.33
	-7	14.66	5.02	13.96	5.65	14.01	6.36	14.06	7.08	13.18	7.19	12.29	7.29
	-2	15.45	4.78	14.72	5.37	14.19	5.83	13.66	6.29	12.98	7.08	12.30	7.86
	2	15.26	4.17	14.53	4.69	13.40	4.83	12.27	4.97	11.65	5.59	11.04	6.21
	7	16.80	3.38	16.00	3.80	15.35	4.20	14.70	4.60	14.60	5.00	14.50	5.40
	10	18.25	3.42	17.38	3.85	16.71	4.25	16.04	4.65	15.24	5.23	14.43	5.81
	15	20.68	3.49	19.69	3.92	18.98	4.26	18.27	4.72	17.36	5.31	16.44	5.90
	20	23.10	3.56	22.00	4.00	21.25	4.36	20.50	4.80	19.48	5.40	18.45	6.00

1. Heating capacity : Capacity is according to Eurovent rating standard OM-3-2015 and valid for heated water range $\Delta t = 3 \sim 8^{\circ}\text{C}$
 2. Cooling capacity : Capacity is according to Eurovent rating standard OM-3-2015 and valid for chilled water range $\Delta t = 3 \sim 8^{\circ}\text{C}$
 3. Power input : Power input is according to Eurovent rating standard OM-3-2015.
 4. Peak value : Tested without defrost operation in accordance with EN14511
 5. Integrated value : Tested with defrost operation in accordance with EN14511
- ※ The real capacity would be changed according to the install environment.

2. Capacity Tables

2-1. AE050/090/120/140/160JXYDEH/EU (1 Phase)

2) Maximum Heating Capacity (Integrated Value)

LWT (Leaving Water Temp.), Tamb (Ambient Temp.), HC (Heating Capacity), PI (Power input)

	LWE(°C)	30		35		40		45		50		55	
	Tamb(°C)	HC(kW)	PI(kW)	HC(kW)	PI(kW)	HC(kW)	PI(kW)	HC(kW)	PI(kW)	HC(kW)	PI(kW)	HC(kW)	PI(kW)
AE050JXYDEH/EU	-20	3.57	1.47	3.40	1.65	3.38	1.75	3.36	2.06				
	-15	4.47	1.67	4.26	1.88	4.08	1.98	3.91	2.08	3.79	2.18		
	-10	5.15	1.74	4.90	1.96	4.75	2.06	4.61	2.16	4.47	2.27	4.15	2.49
	-7	4.94	1.56	4.70	1.75	4.60	1.98	4.50	2.20	4.60	2.40	4.70	2.60
	-2	4.83	1.36	4.60	1.53	4.43	1.68	4.25	1.83	4.04	2.05	3.83	2.28
	2	4.73	1.16	4.50	1.30	4.25	1.38	4.00	1.45	3.80	1.63	3.60	1.81
	7	5.25	0.94	5.00	1.06	4.85	1.21	4.70	1.35	4.60	1.48	4.50	1.60
	10	5.73	0.95	5.46	1.07	5.32	1.22	5.18	1.36	4.93	1.53	4.67	1.70
	15	6.54	0.97	6.23	1.08	6.11	1.21	5.99	1.38	5.69	1.55	5.39	1.73
	20	7.35	0.98	7.00	1.10	6.90	1.24	6.80	1.40	6.46	1.58	6.12	1.75
AE090JXYDEH/EU	-20	6.30	2.67	6.00	3.00	5.85	3.20	5.70	3.53				
	-15	7.38	2.82	7.03	3.17	6.83	3.37	6.63	3.56	6.43	3.74		
	-10	8.85	2.97	8.43	3.33	8.18	3.52	7.92	3.70	7.68	3.89	7.13	4.26
	-7	7.98	2.83	7.60	3.18	7.38	3.34	7.15	3.50	6.53	3.60	5.90	3.70
	-2	7.67	2.45	7.30	2.76	7.06	2.90	6.83	3.05	6.48	3.43	6.14	3.81
	2	7.35	2.07	7.00	2.33	6.75	2.47	6.50	2.60	6.18	2.93	5.85	3.25
	7	9.45	1.90	9.00	2.14	8.55	2.27	8.10	2.39	8.05	2.68	8.00	2.96
	10	10.38	1.90	9.89	2.14	9.47	2.29	9.06	2.44	8.61	2.75	8.15	3.05
	15	11.93	1.89	11.36	2.13	11.01	2.29	10.66	2.53	10.13	2.85	9.59	3.16
	20	13.48	1.89	12.84	2.12	12.55	2.35	12.26	2.62	11.65	2.95	11.03	3.27
AE120JXYDEH/EU	-20	9.82	4.09	9.35	4.60	8.93	4.90	8.50	5.29				
	-15	11.02	4.23	10.49	4.75	10.20	5.05	9.90	5.35	9.60	5.61		
	-10	12.14	4.01	11.56	4.51	11.22	5.03	10.87	5.56	10.54	5.83	9.78	6.39
	-7	10.82	3.52	10.30	3.95	9.85	4.34	9.39	4.73	8.93	5.12	8.47	5.51
	-2	10.55	3.07	10.05	3.45	9.87	3.86	9.70	4.27	9.21	4.80	8.73	5.33
	2	10.29	2.63	9.80	2.95	9.90	3.38	10.00	3.80	9.50	4.28	9.00	4.75
	7	12.60	2.37	12.00	2.66	11.70	3.06	11.40	3.45	10.95	3.68	10.50	3.90
	10	13.91	2.35	13.25	2.64	12.89	3.02	12.54	3.40	11.91	3.83	11.28	4.25
	15	16.09	2.31	15.32	2.60	14.88	2.92	14.43	3.33	13.71	3.74	12.98	4.16
	20	18.27	2.28	17.40	2.56	16.86	2.88	16.32	3.25	15.50	3.66	14.69	4.06
AE140JXYDEH/EU	-20	10.13	4.36	9.65	4.90	9.33	5.20	9.01	5.59				
	-15	11.64	4.49	11.09	5.05	10.79	5.35	10.49	5.64	10.18	5.93		
	-10	13.17	4.54	12.54	5.10	12.17	5.48	11.79	5.87	11.44	6.16	10.61	6.75
	-7	11.34	3.76	10.80	4.22	10.75	4.94	10.70	5.65	10.35	5.78	10.00	5.90
	-2	11.55	3.41	11.00	3.83	10.96	4.45	10.93	5.08	10.38	5.71	9.83	6.34
	2	11.76	3.06	11.20	3.44	11.18	3.97	11.15	4.50	10.59	5.06	10.04	5.63
	7	14.70	2.79	14.00	3.14	13.50	3.55	13.00	3.95	12.63	4.20	12.25	4.45
	10	15.67	2.79	14.92	3.13	14.42	3.52	13.92	3.90	13.23	4.39	12.53	4.87
	15	17.28	2.77	16.46	3.12	15.96	3.41	15.46	3.81	14.69	4.29	13.92	4.77
	20	18.90	2.76	18.00	3.10	17.50	3.38	17.00	3.73	16.15	4.20	15.30	4.66
AE160JXYDEH/EU	-20	11.87	5.30	11.30	5.95	10.75	6.25	10.20	6.76				
	-15	13.51	5.55	12.87	6.24	12.38	6.53	11.88	6.83	11.52	7.17		
	-10	14.82	5.32	14.11	5.98	13.69	6.54	13.27	7.10	12.87	7.46	11.94	8.17
	-7	14.07	4.82	13.40	5.42	13.45	6.11	13.50	6.80	12.65	6.90	11.80	7.00
	-2	13.60	4.21	12.95	4.73	12.49	5.13	12.03	5.54	11.42	6.23	10.82	6.92
	2	13.13	3.59	12.50	4.03	11.53	4.15	10.55	4.27	10.02	4.80	9.50	5.34
	7	16.80	3.38	16.00	3.80	15.35	4.20	14.70	4.60	14.60	5.00	14.50	5.40
	10	18.25	3.42	17.38	3.85	16.71	4.25	16.04	4.65	15.24	5.23	14.43	5.81
	15	20.68	3.49	19.69	3.92	18.98	4.26	18.27	4.72	17.36	5.31	16.44	5.90
	20	23.10	3.56	22.00	4.00	21.25	4.36	20.50	4.80	19.48	5.40	18.45	6.00

1. Heating capacity : Capacity is according to Eurovent rating standard OM-3-2015 and valid for heated water range $\Delta t = 3 \sim 8^{\circ}\text{C}$

2. Cooling capacity : Capacity is according to Eurovent rating standard OM-3-2015 and valid for chilled water range $\Delta t = 3 \sim 8^{\circ}\text{C}$

3. Power input : Power input is according to Eurovent rating standard OM-3-2015.

4. Peak value : Tested without defrost operation in accordance with EN14511

5. Integrated value : Tested with defrost operation in accordance with EN14511

※ The real capacity would be changed according to the install environment.

2. Capacity Tables

2-1. AE050/090/120/140/160JXYDEH/EU (1 Phase)

3) Maximum Cooling Capacity

LWT (Leaving Water Temp.), Tamb (Ambient Temp.), CC (Cooling Capacity), PI (Power input)

AE050JXYDEH/EU	LWE(°C)	7		10		13		15		18		25	
	Tamb(°C)	CC(kW)	PI(kW)	CC(kW)	PI(kW)	CC(kW)	PI(kW)	CC(kW)	PI(kW)	CC(kW)	PI(kW)	CC(kW)	PI(kW)
	10	4.21	0.90	4.54	0.90	4.87	0.90	5.20	0.90	5.54	0.90	6.09	0.92
	20	4.05	1.02	4.37	1.02	4.69	1.02	5.01	1.02	5.33	1.02	5.86	1.04
	30	3.88	1.14	4.19	1.14	4.50	1.14	4.80	1.14	5.11	1.14	5.62	1.17
	35	3.80	1.21	4.10	1.21	4.40	1.21	4.70	1.21	5.00	1.21	5.50	1.23
	46	3.62	1.34	3.91	1.34	4.19	1.34	4.48	1.34	4.77	1.34	5.24	1.36
AE090JXYDEH/EU	LWE(°C)	7		10		13		15		18		25	
	Tamb(°C)	CC(kW)	PI(kW)	CC(kW)	PI(kW)	CC(kW)	PI(kW)	CC(kW)	PI(kW)	CC(kW)	PI(kW)	CC(kW)	PI(kW)
	10	6.09	1.39	6.64	1.41	7.18	1.44	7.55	1.46	8.09	1.49	8.82	1.52
	20	5.86	1.57	6.40	1.60	6.95	1.63	7.31	1.65	7.86	1.67	8.58	1.71
	30	5.62	1.76	6.16	1.78	6.71	1.81	7.07	1.83	7.62	1.86	8.35	1.89
	35	5.50	1.85	6.05	1.88	6.59	1.90	6.95	1.92	7.50	1.95	8.23	1.99
	46	5.24	2.05	5.78	2.08	6.33	2.11	6.69	2.13	7.24	2.15	7.97	2.19
AE120JXYDEH/EU	LWE(°C)	7		10		13		15		18		25	
	Tamb(°C)	CC(kW)	PI(kW)	CC(kW)	PI(kW)	CC(kW)	PI(kW)	CC(kW)	PI(kW)	CC(kW)	PI(kW)	CC(kW)	PI(kW)
	10	9.97	2.37	10.79	2.37	11.61	2.37	12.15	2.37	12.97	2.37	14.06	2.37
	20	9.58	2.69	10.40	2.69	11.22	2.69	11.77	2.69	12.58	2.69	13.67	2.69
	30	9.19	3.00	10.01	3.00	10.83	3.00	11.38	3.00	12.19	3.00	13.29	3.00
	35	9.00	3.16	9.82	3.16	10.64	3.16	11.18	3.16	12.00	3.16	13.09	3.16
	46	8.57	3.51	9.39	3.51	10.21	3.51	10.75	3.51	11.57	3.51	12.66	3.51
AE140JXYDEH/EU	LWE(°C)	7		10		13		15		18		25	
	Tamb(°C)	CC(kW)	PI(kW)	CC(kW)	PI(kW)	CC(kW)	PI(kW)	CC(kW)	PI(kW)	CC(kW)	PI(kW)	CC(kW)	PI(kW)
	10	10.76	2.62	11.66	2.63	12.56	2.64	13.16	2.65	14.06	2.67	15.26	2.68
	20	10.33	2.95	11.23	2.96	12.13	2.98	12.73	2.99	13.63	3.00	14.83	3.02
	30	9.91	3.28	10.81	3.30	11.71	3.31	12.31	3.32	13.21	3.33	14.41	3.35
	35	9.70	3.45	10.60	3.46	11.50	3.48	12.10	3.49	13.00	3.50	14.20	3.52
	46	9.24	3.82	10.14	3.83	11.04	3.84	11.64	3.85	12.54	3.87	13.74	3.89
AE160JXYDEH/EU	LWE(°C)	7		10		13		15		18		25	
	Tamb(°C)	CC(kW)	PI(kW)	CC(kW)	PI(kW)	CC(kW)	PI(kW)	CC(kW)	PI(kW)	CC(kW)	PI(kW)	CC(kW)	PI(kW)
	10	11.54	2.85	12.52	2.88	13.50	2.90	14.15	2.92	15.14	2.94	16.44	2.98
	20	11.08	3.21	12.06	3.24	13.04	3.26	13.70	3.28	14.68	3.30	15.99	3.34
	30	10.63	3.57	11.61	3.60	12.59	3.62	13.25	3.64	14.23	3.66	15.54	3.69
	35	10.40	3.75	11.38	3.77	12.36	3.80	13.02	3.82	14.00	3.84	15.31	3.87
	46	9.90	4.14	10.88	4.17	11.86	4.19	12.52	4.21	13.50	4.23	14.81	4.27

1. Heating capacity : Capacity is according to Eurovent rating standard OM-3-2015 and valid for heated water range $\Delta t = 3 \sim 8^{\circ}\text{C}$

2. Cooling capacity : Capacity is according to Eurovent rating standard OM-3-2015 and valid for chilled water range $\Delta t = 3 \sim 8^{\circ}\text{C}$

3. Power input : Power input is according to Eurovent rating standard OM-3-2015.

4. Peak value : Tested without defrost operation in accordance with EN14511

5. Integrated value : Tested with defrost operation in accordance with EN14511

※ The real capacity would be changed according to the install environment.

2. Capacity Tables

2-2. AE090/120/140/160JXYDGH/EU (3 Phase)

1) Maximum Heating Capacity (Peak Value)

LWT (Leaving Water Temp.), Tamb (Ambient Temp.), HC (Heating Capacity), PI (Power input)

	LWE(°C)	30		35		40		45		50		55	
	Tamb(°C)	HC(kW)	PI(kW)	HC(kW)	PI(kW)	HC(kW)	PI(kW)	HC(kW)	PI(kW)	HC(kW)	PI(kW)	HC(kW)	PI(kW)
AE090JXYDGH/EU	-20	6.30	2.67	6.00	3.00	5.85	3.20	5.70	3.53				
	-15	7.46	2.85	7.10	3.20	6.90	3.40	6.70	3.60	6.50	3.78		
	-10	9.03	3.03	8.60	3.40	8.34	3.59	8.08	3.78	7.84	3.97	7.28	4.35
	-7	8.31	2.95	7.92	3.31	7.68	3.48	7.45	3.65	6.80	3.75	6.15	3.85
	-2	8.71	2.79	8.30	3.13	8.03	3.30	7.76	3.47	7.37	3.90	6.98	4.33
	2	8.55	2.41	8.14	2.71	7.85	2.87	7.56	3.02	7.18	3.40	6.80	3.78
	7	9.45	1.90	9.00	2.14	8.55	2.27	8.10	2.39	8.05	2.68	8.00	2.96
	10	10.38	1.90	9.89	2.14	9.47	2.29	9.06	2.44	8.61	2.75	8.15	3.05
	15	11.93	1.89	11.36	2.13	11.01	2.29	10.66	2.53	10.13	2.85	9.59	3.16
	20	13.48	1.89	12.84	2.12	12.55	2.35	12.26	2.62	11.65	2.95	11.03	3.27
AE120JXYDGH/EU	LWE(°C)	30		35		40		45		50		55	
	Tamb(°C)	HC(kW)	PI(kW)	HC(kW)	PI(kW)	HC(kW)	PI(kW)	HC(kW)	PI(kW)	HC(kW)	PI(kW)	HC(kW)	PI(kW)
	-20	9.82	4.09	9.35	4.60	8.93	4.90	8.50	5.29				
	-15	11.13	4.27	10.60	4.80	10.30	5.10	10.00	5.40	9.70	5.67		
	-10	12.39	4.09	11.80	4.60	11.45	5.14	11.09	5.67	10.76	5.95	9.98	6.52
	-7	11.27	3.66	10.73	4.11	10.26	4.52	9.78	4.93	9.30	5.33	8.82	5.74
	-2	11.99	3.49	11.42	3.92	11.22	4.38	11.02	4.85	10.47	5.45	9.92	6.06
	2	11.97	3.05	11.40	3.43	11.51	3.92	11.63	4.42	11.05	4.97	10.47	5.52
	7	12.60	2.37	12.00	2.66	11.70	3.06	11.40	3.45	10.95	3.68	10.50	3.90
	10	13.91	2.35	13.25	2.64	12.89	3.02	12.54	3.40	11.91	3.83	11.28	4.25
15	16.09	2.31	15.32	2.60	14.88	2.92	14.43	3.33	13.71	3.74	12.98	4.16	
20	18.27	2.28	17.40	2.56	16.86	2.88	16.32	3.25	15.50	3.66	14.69	4.06	
AE140JXYDGH/EU	LWE(°C)	30		35		40		45		50		55	
	Tamb(°C)	HC(kW)	PI(kW)	HC(kW)	PI(kW)	HC(kW)	PI(kW)	HC(kW)	PI(kW)	HC(kW)	PI(kW)	HC(kW)	PI(kW)
	-20	10.13	4.36	9.65	4.90	9.33	5.20	9.01	5.59				
	-15	11.76	4.54	11.20	5.10	10.90	5.40	10.60	5.70	10.28	5.99		
	-10	13.44	4.63	12.80	5.20	12.42	5.59	12.03	5.99	11.67	6.28	10.83	6.88
	-7	11.81	3.91	11.25	4.40	11.20	5.14	11.15	5.89	10.78	6.02	10.42	6.15
	-2	13.13	3.87	12.50	4.35	12.46	5.06	12.41	5.77	11.79	6.49	11.17	7.21
	2	13.67	3.56	13.02	4.00	12.99	4.62	12.97	5.23	12.32	5.89	11.67	6.54
	7	14.70	2.79	14.00	3.14	13.50	3.55	13.00	3.95	12.63	4.20	12.25	4.45
	10	15.67	2.79	14.92	3.13	14.42	3.52	13.92	3.90	13.23	4.39	12.53	4.87
15	17.28	2.77	16.46	3.12	15.96	3.41	15.46	3.81	14.69	4.29	13.92	4.77	
20	18.90	2.76	18.00	3.10	17.50	3.38	17.00	3.73	16.15	4.20	15.30	4.66	
AE160JXYDGH/EU	LWE(°C)	30		35		40		45		50		55	
	Tamb(°C)	HC(kW)	PI(kW)	HC(kW)	PI(kW)	HC(kW)	PI(kW)	HC(kW)	PI(kW)	HC(kW)	PI(kW)	HC(kW)	PI(kW)
	-20	11.87	5.30	11.30	5.95	10.75	6.25	10.20	6.76				
	-15	13.65	5.61	13.00	6.30	12.50	6.60	12.00	6.90	11.64	7.25		
	-10	15.12	5.43	14.40	6.10	13.97	6.67	13.54	7.25	13.13	7.61	12.18	8.33
	-7	14.66	5.02	13.96	5.65	14.01	6.36	14.06	7.08	13.18	7.19	12.29	7.29
	-2	15.45	4.78	14.72	5.37	14.19	5.83	13.66	6.29	12.98	7.08	12.30	7.86
	2	15.26	4.17	14.53	4.69	13.40	4.83	12.27	4.97	11.65	5.59	11.04	6.21
	7	16.80	3.38	16.00	3.80	15.35	4.20	14.70	4.60	14.60	5.00	14.50	5.40
	10	18.25	3.42	17.38	3.85	16.71	4.25	16.04	4.65	15.24	5.23	14.43	5.81
15	20.68	3.49	19.69	3.92	18.98	4.26	18.27	4.72	17.36	5.31	16.44	5.90	
20	23.10	3.56	22.00	4.00	21.25	4.36	20.50	4.80	19.48	5.40	18.45	6.00	

1. Heating capacity : Capacity is according to Eurovent rating standard OM-3-2015 and valid for heated water range $\Delta t = 3 \sim 8^{\circ}\text{C}$
 2. Cooling capacity : Capacity is according to Eurovent rating standard OM-3-2015 and valid for chilled water range $\Delta t = 3 \sim 8^{\circ}\text{C}$
 3. Power input : Power input is according to Eurovent rating standard OM-3-2015.
 4. Peak value : Tested without defrost operation in accordance with EN14511
 5. Integrated value : Tested with defrost operation in accordance with EN14511
- ※ The real capacity would be changed according to the install environment.

2. Capacity Tables

2-2. AE090/120/140/160JXYDGH/EU (3 Phase)

2) Maximum Heating Capacity (Integrated Value)

LWT (Leaving Water Temp.), Tamb (Ambient Temp.), HC (Heating Capacity), PI (Power input)

	LWE(°C)	30		35		40		45		50		55	
	Tamb(°C)	HC(kW)	PI(kW)	HC(kW)	PI(kW)	HC(kW)	PI(kW)	HC(kW)	PI(kW)	HC(kW)	PI(kW)	HC(kW)	PI(kW)
AE090JXYDGH/EU	-20	6.30	2.67	6.00	3.00	5.85	3.20	5.70	3.53				
	-15	7.38	2.82	7.03	3.17	6.83	3.37	6.63	3.56	6.43	3.74		
	-10	8.85	2.97	8.43	3.33	8.18	3.52	7.92	3.70	7.68	3.89	7.13	4.26
	-7	7.98	2.83	7.60	3.18	7.38	3.34	7.15	3.50	6.53	3.60	5.90	3.70
	-2	7.67	2.45	7.30	2.76	7.06	2.90	6.83	3.05	6.48	3.43	6.14	3.81
	2	7.35	2.07	7.00	2.33	6.75	2.47	6.50	2.60	6.18	2.93	5.85	3.25
	7	9.45	1.90	9.00	2.14	8.55	2.27	8.10	2.39	8.05	2.68	8.00	2.96
	10	10.38	1.90	9.89	2.14	9.47	2.29	9.06	2.44	8.61	2.75	8.15	3.05
	15	11.93	1.89	11.36	2.13	11.01	2.29	10.66	2.53	10.13	2.85	9.59	3.16
	20	13.48	1.89	12.84	2.12	12.55	2.35	12.26	2.62	11.65	2.95	11.03	3.27
AE120JXYDGH/EU	-20	9.82	4.09	9.35	4.60	8.93	4.90	8.50	5.29				
	-15	11.02	4.23	10.49	4.75	10.20	5.05	9.90	5.35	9.60	5.61		
	-10	12.14	4.01	11.56	4.51	11.22	5.03	10.87	5.56	10.54	5.83	9.78	6.39
	-7	10.82	3.52	10.30	3.95	9.85	4.34	9.39	4.73	8.93	5.12	8.47	5.51
	-2	10.55	3.07	10.05	3.45	9.87	3.86	9.70	4.27	9.21	4.80	8.73	5.33
	2	10.29	2.63	9.80	2.95	9.90	3.38	10.00	3.80	9.50	4.28	9.00	4.75
	7	12.60	2.37	12.00	2.66	11.70	3.06	11.40	3.45	10.95	3.68	10.50	3.90
	10	13.91	2.35	13.25	2.64	12.89	3.02	12.54	3.40	11.91	3.83	11.28	4.25
	15	16.09	2.31	15.32	2.60	14.88	2.92	14.43	3.33	13.71	3.74	12.98	4.16
	20	18.27	2.28	17.40	2.56	16.86	2.88	16.32	3.25	15.50	3.66	14.69	4.06
AE140JXYDGH/EU	-20	10.13	4.36	9.65	4.90	9.33	5.20	9.01	5.59				
	-15	11.64	4.49	11.09	5.05	10.79	5.35	10.49	5.64	10.18	5.93		
	-10	13.17	4.54	12.54	5.10	12.17	5.48	11.79	5.87	11.44	6.16	10.61	6.75
	-7	11.34	3.76	10.80	4.22	10.75	4.94	10.70	5.65	10.35	5.78	10.00	5.90
	-2	11.55	3.41	11.00	3.83	10.96	4.45	10.93	5.08	10.38	5.71	9.83	6.34
	2	11.76	3.06	11.20	3.44	11.18	3.97	11.15	4.50	10.59	5.06	10.04	5.63
	7	14.70	2.79	14.00	3.14	13.50	3.55	13.00	3.95	12.63	4.20	12.25	4.45
	10	15.67	2.79	14.92	3.13	14.42	3.52	13.92	3.90	13.23	4.39	12.53	4.87
	15	17.28	2.77	16.46	3.12	15.96	3.41	15.46	3.81	14.69	4.29	13.92	4.77
	20	18.90	2.76	18.00	3.10	17.50	3.38	17.00	3.73	16.15	4.20	15.30	4.66
AE160JXYDGH/EU	-20	11.87	5.30	11.30	5.95	10.75	6.25	10.20	6.76				
	-15	13.51	5.55	12.87	6.24	12.38	6.53	11.88	6.83	11.52	7.17		
	-10	14.82	5.32	14.11	5.98	13.69	6.54	13.27	7.10	12.87	7.46	11.94	8.17
	-7	14.07	4.82	13.40	5.42	13.45	6.11	13.50	6.80	12.65	6.90	11.80	7.00
	-2	13.60	4.21	12.95	4.73	12.49	5.13	12.03	5.54	11.42	6.23	10.82	6.92
	2	13.13	3.59	12.50	4.03	11.53	4.15	10.55	4.27	10.02	4.80	9.50	5.34
	7	16.80	3.38	16.00	3.80	15.35	4.20	14.70	4.60	14.60	5.00	14.50	5.40
	10	18.25	3.42	17.38	3.85	16.71	4.25	16.04	4.65	15.24	5.23	14.43	5.81
	15	20.68	3.49	19.69	3.92	18.98	4.26	18.27	4.72	17.36	5.31	16.44	5.90
	20	23.10	3.56	22.00	4.00	21.25	4.36	20.50	4.80	19.48	5.40	18.45	6.00

1. Heating capacity : Capacity is according to Eurovent rating standard OM-3-2015 and valid for heated water range $\Delta t = 3 \sim 8^{\circ}\text{C}$
 2. Cooling capacity : Capacity is according to Eurovent rating standard OM-3-2015 and valid for chilled water range $\Delta t = 3 \sim 8^{\circ}\text{C}$
 3. Power input : Power input is according to Eurovent rating standard OM-3-2015.
 4. Peak value : Tested without defrost operation in accordance with EN14511
 5. Integrated value : Tested with defrost operation in accordance with EN14511
- ※ The real capacity would be changed according to the install environment.

2. Capacity Tables

2-2. AE090/120/140/160JXYDGH/EU (3 Phase)

3) Maximum Cooling Capacity

LWT (Leaving Water Temp.), Tamb (Ambient Temp.), CC (Cooling Capacity), PI (Power input)

AE090JXYDGH/EU	LWE(°C)	7		10		13		15		18		25	
	Tamb(°C)	CC(kW)	PI(kW)	CC(kW)	PI(kW)	CC(kW)	PI(kW)	CC(kW)	PI(kW)	CC(kW)	PI(kW)	CC(kW)	PI(kW)
	10	6.09	1.19	6.50	1.41	6.91	1.44	7.18	1.46	7.59	1.49	8.14	1.55
	20	5.86	1.23	6.27	1.60	6.67	1.63	6.95	1.65	7.36	1.67	7.90	1.74
	30	5.62	1.24	6.03	1.78	6.44	1.81	6.71	1.83	7.12	1.86	7.66	1.92
	35	5.50	1.94	5.91	1.88	6.32	1.90	6.59	1.92	7.00	1.92	7.55	2.01
	46	5.24	1.24	5.65	2.08	6.06	2.11	6.33	2.13	6.74	2.15	7.28	2.22
AE120JXYDGH/EU	LWE(°C)	7		10		13		15		18		25	
	Tamb(°C)	CC(kW)	PI(kW)	CC(kW)	PI(kW)	CC(kW)	PI(kW)	CC(kW)	PI(kW)	CC(kW)	PI(kW)	CC(kW)	PI(kW)
	10	9.97	2.37	10.79	2.37	11.61	2.37	12.15	2.37	12.97	2.37	14.06	2.37
	20	9.58	2.69	10.40	2.69	11.22	2.69	11.77	2.69	12.58	2.69	13.67	2.69
	30	9.19	3.00	10.01	3.00	10.83	3.00	11.38	3.00	12.19	3.00	13.29	3.00
	35	9.00	3.16	9.82	3.16	10.64	3.16	11.18	3.16	12.00	3.16	13.09	3.16
	46	8.57	3.51	9.39	3.51	10.21	3.51	10.75	3.51	11.57	3.51	12.66	3.51
AE140JXYDGH/EU	LWE(°C)	7		10		13		15		18		25	
	Tamb(°C)	CC(kW)	PI(kW)	CC(kW)	PI(kW)	CC(kW)	PI(kW)	CC(kW)	PI(kW)	CC(kW)	PI(kW)	CC(kW)	PI(kW)
	10	10.76	2.62	11.66	2.63	12.56	2.64	13.16	2.65	14.06	2.67	15.26	2.68
	20	10.33	2.95	11.23	2.96	12.13	2.98	12.73	2.99	13.63	3.00	14.83	3.02
	30	9.91	3.28	10.81	3.30	11.71	3.31	12.31	3.32	13.21	3.33	14.41	3.35
	35	9.70	3.45	10.60	3.46	11.50	3.48	12.10	3.49	13.00	3.50	14.20	3.52
	46	9.24	3.82	10.14	3.83	11.04	3.84	11.64	3.85	12.54	3.87	13.74	3.89
AE160JXYDGH/EU	LWE(°C)	7		10		13		15		18		25	
	Tamb(°C)	CC(kW)	PI(kW)	CC(kW)	PI(kW)	CC(kW)	PI(kW)	CC(kW)	PI(kW)	CC(kW)	PI(kW)	CC(kW)	PI(kW)
	10	11.54	2.85	12.52	2.88	13.50	2.90	14.15	2.92	15.14	2.94	16.44	2.98
	20	11.08	3.21	12.06	3.24	13.04	3.26	13.70	3.28	14.68	3.30	15.99	3.34
	30	10.63	3.57	11.61	3.60	12.59	3.62	13.25	3.64	14.23	3.66	15.54	3.69
	35	10.40	3.75	11.38	3.77	12.36	3.80	13.02	3.82	14.00	3.84	15.31	3.87
	46	9.90	4.14	10.88	4.17	11.86	4.19	12.52	4.21	13.50	4.23	14.81	4.27

1. Heating capacity : Capacity is according to Eurovent rating standard OM-3-2015 and valid for heated water range $\Delta t = 3 \sim 8^{\circ}\text{C}$

2. Cooling capacity : Capacity is according to Eurovent rating standard OM-3-2015 and valid for chilled water range $\Delta t = 3 \sim 8^{\circ}\text{C}$

3. Power input : Power input is according to Eurovent rating standard OM-3-2015.

4. Peak value : Tested without defrost operation in accordance with EN14511

5. Integrated value : Tested with defrost operation in accordance with EN14511

※ The real capacity would be changed according to the install environment.

3. Dimensional Drawings

3-1. Outdoor Unit

1) AE050JXYD*H/EU

(Unit : mm)

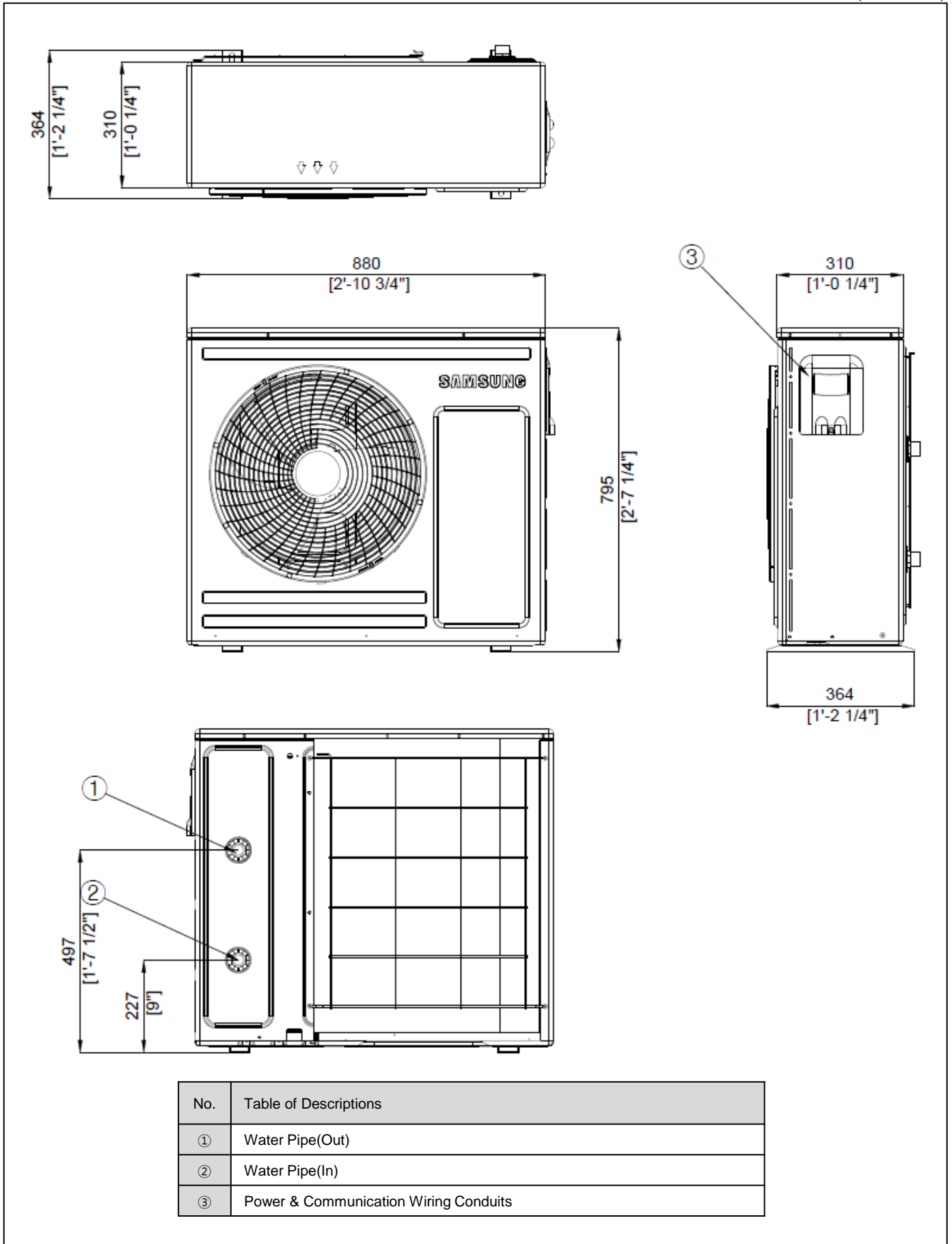

3. Dimensional Drawings

3-1. Outdoor Unit

2) AE090JXYD*H/EU

(Unit : mm)

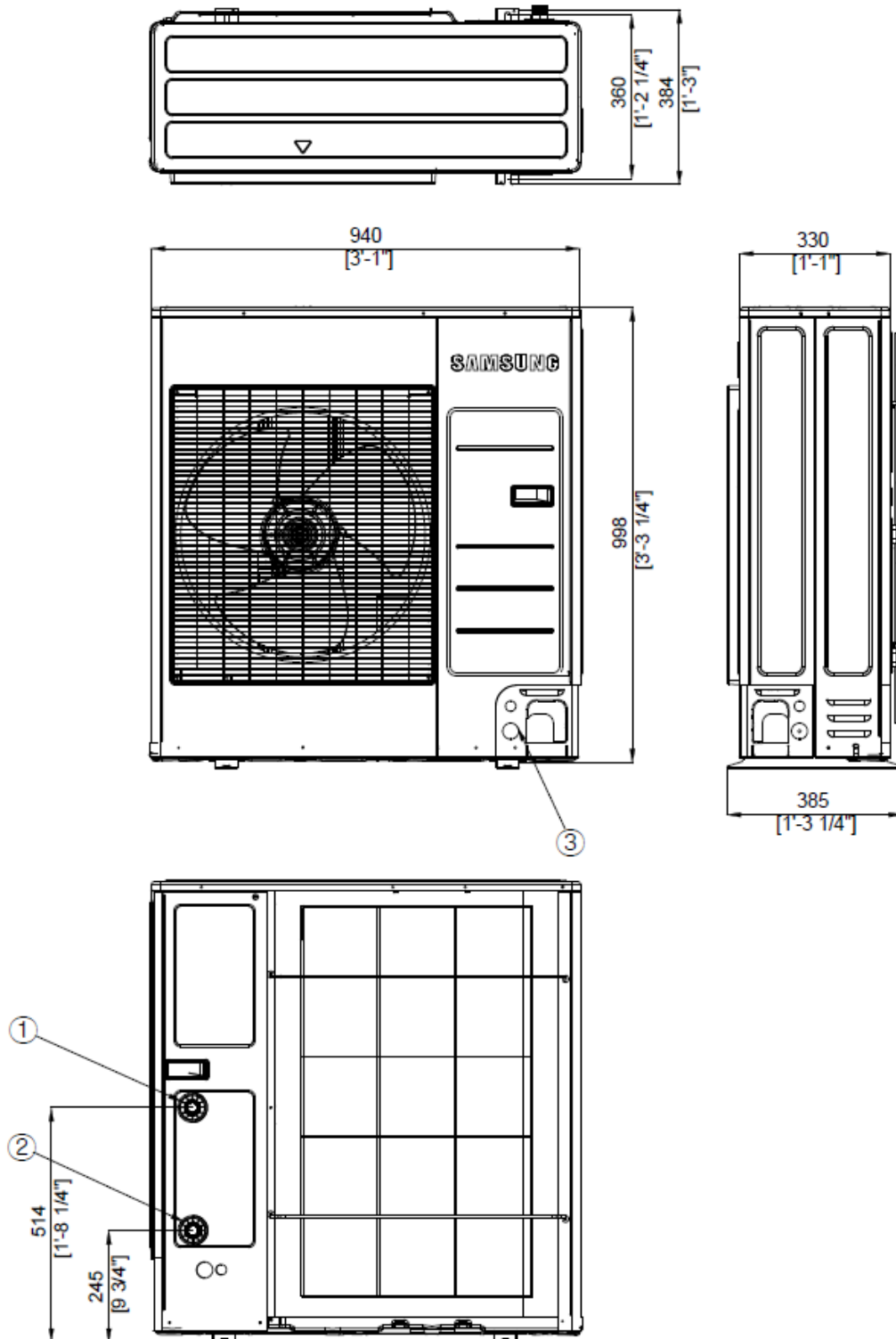

No.	Table of Descriptions
①	Water Pipe(Out)
②	Water Pipe(In)
③	Power & Communication Wiring Conduits

3. Dimensional Drawings

3-1. Outdoor Unit

3) AE120/140/160JXYD*H/EU

(Unit : mm)

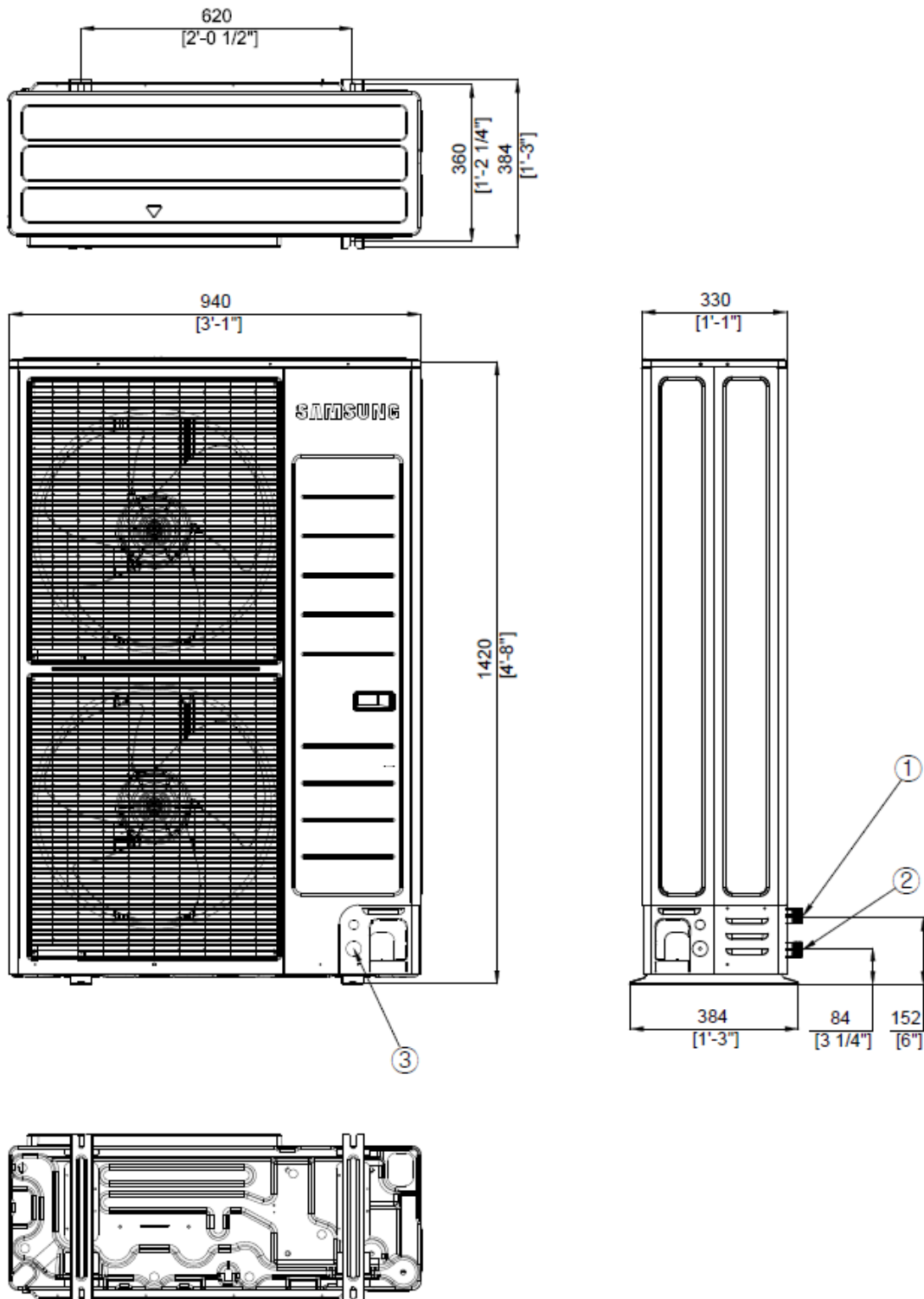

No.	Table of Descriptions
①	Water Pipe(Out)
②	Water Pipe(In)
③	Power & Communication Wiring Conduits

3. Dimensional Drawings

3-2. Control Kit

1) MIM-E03A(B)N

(Unit : mm)

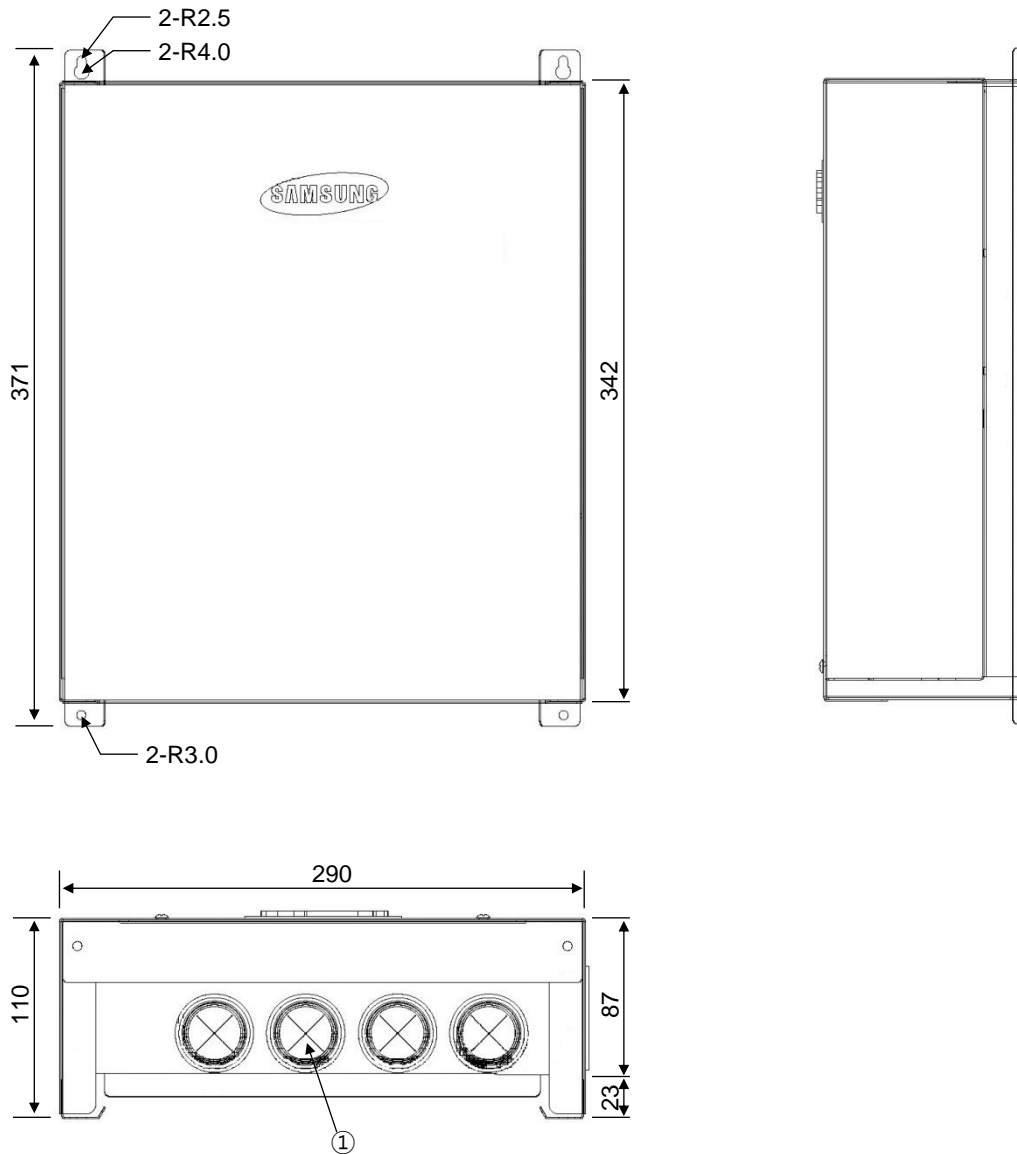

No.	Table of Descriptions
①	Conduit for Wiring (Rubber)

4. Piping Diagrams

4-1. AE050JXYDEH/EU

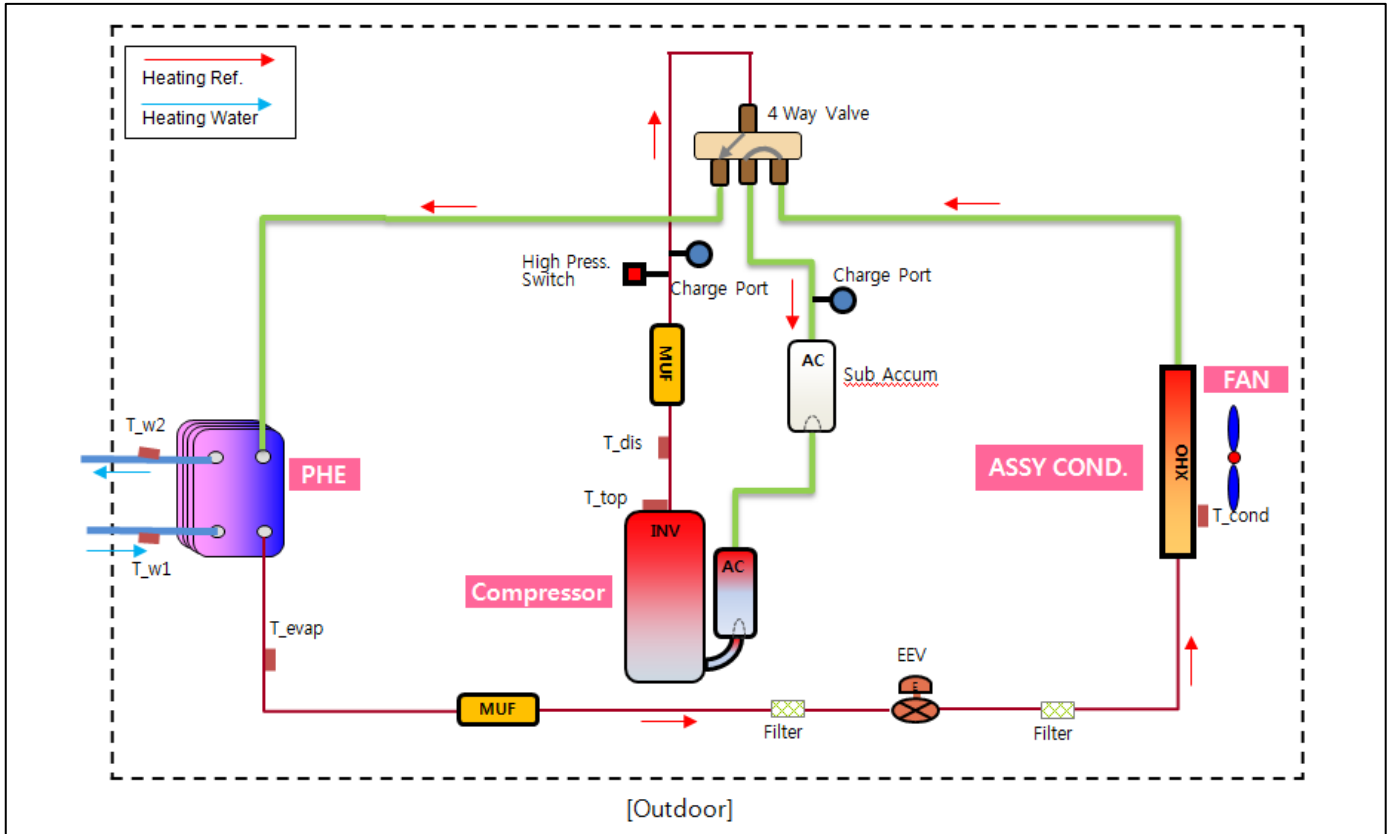

4-2. AE090JXYD*H/EU

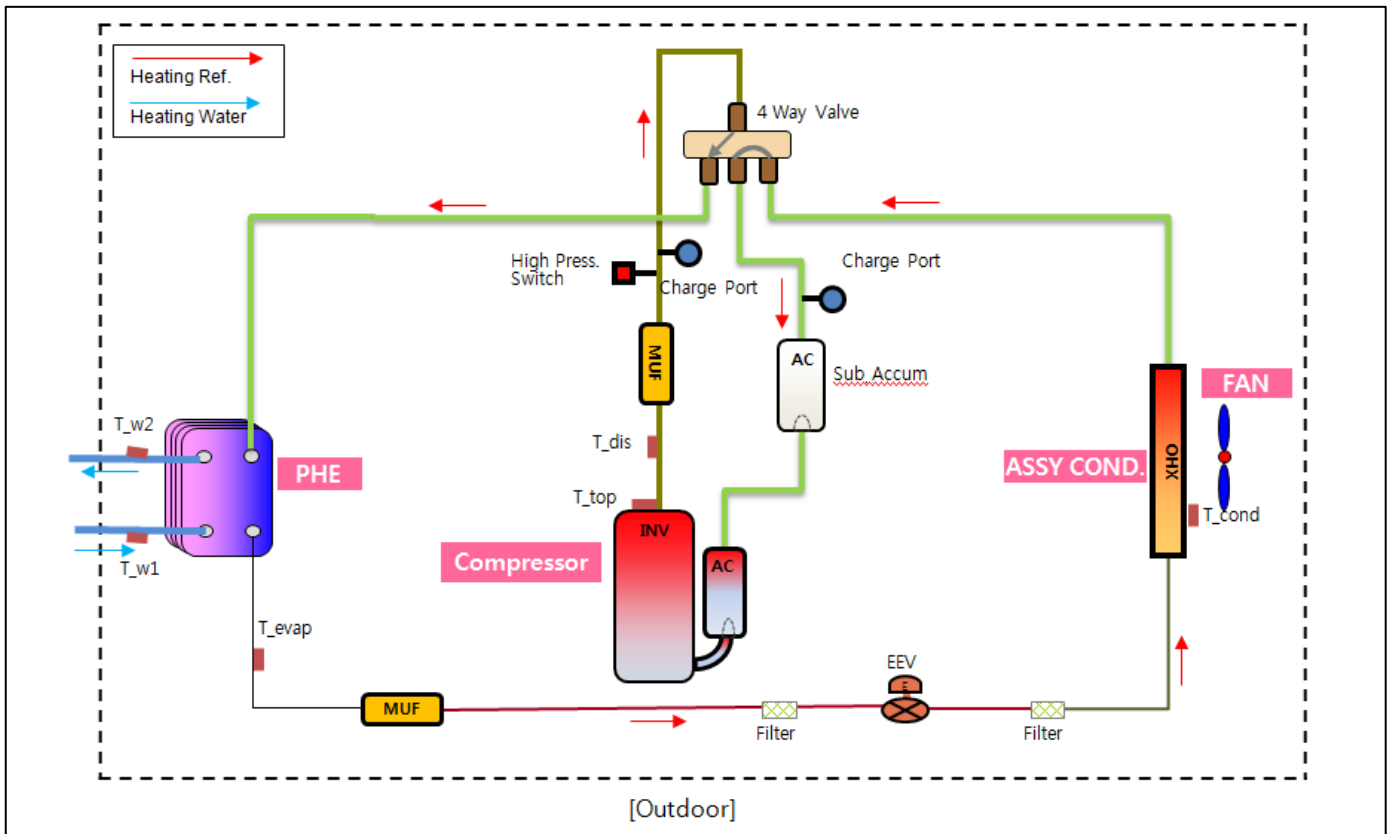

4. Piping Diagrams

4-3. AE120/140/160JXYD*H/EU

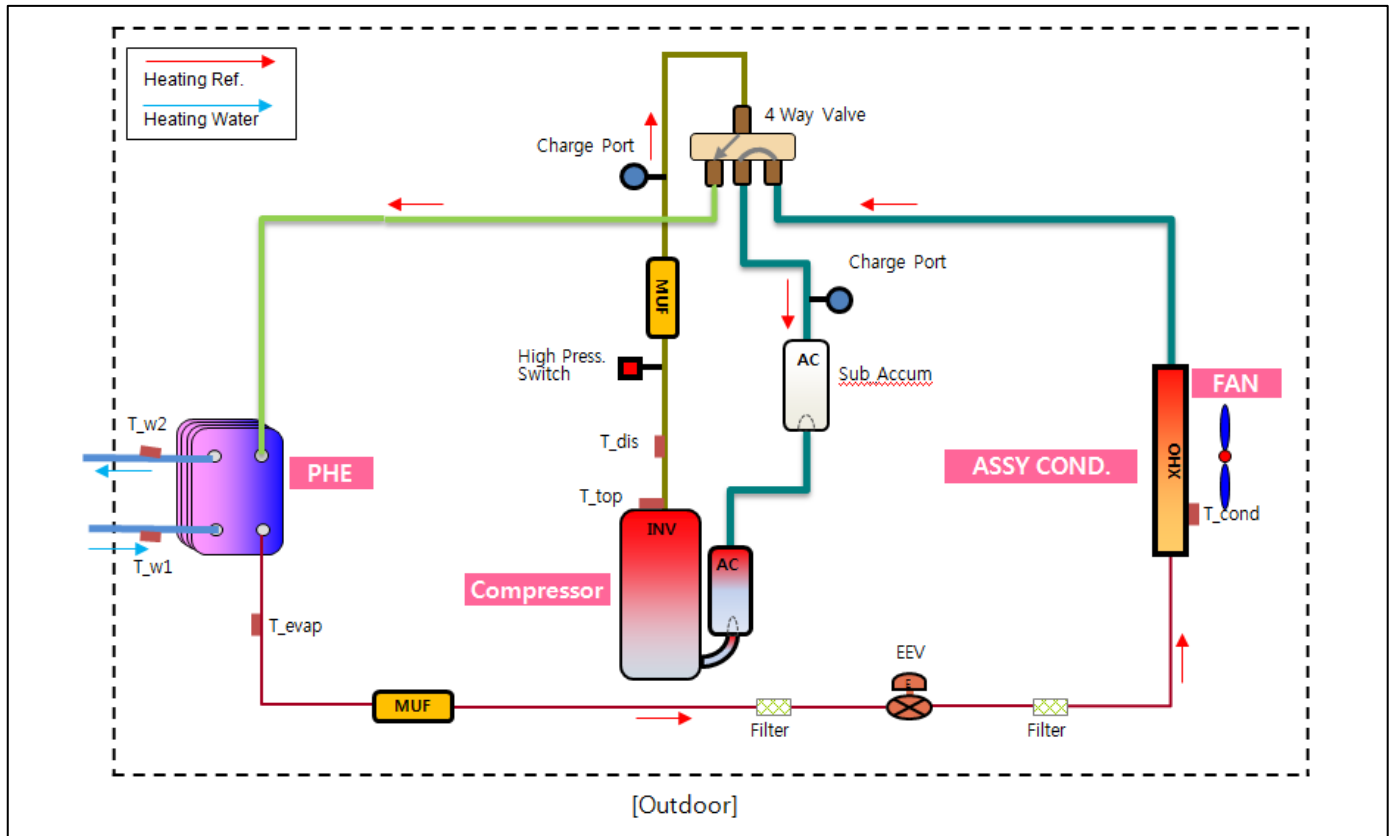

5. Wiring Diagrams

5-1. Outdoor Unit

1) AE050JXYDEH/EU

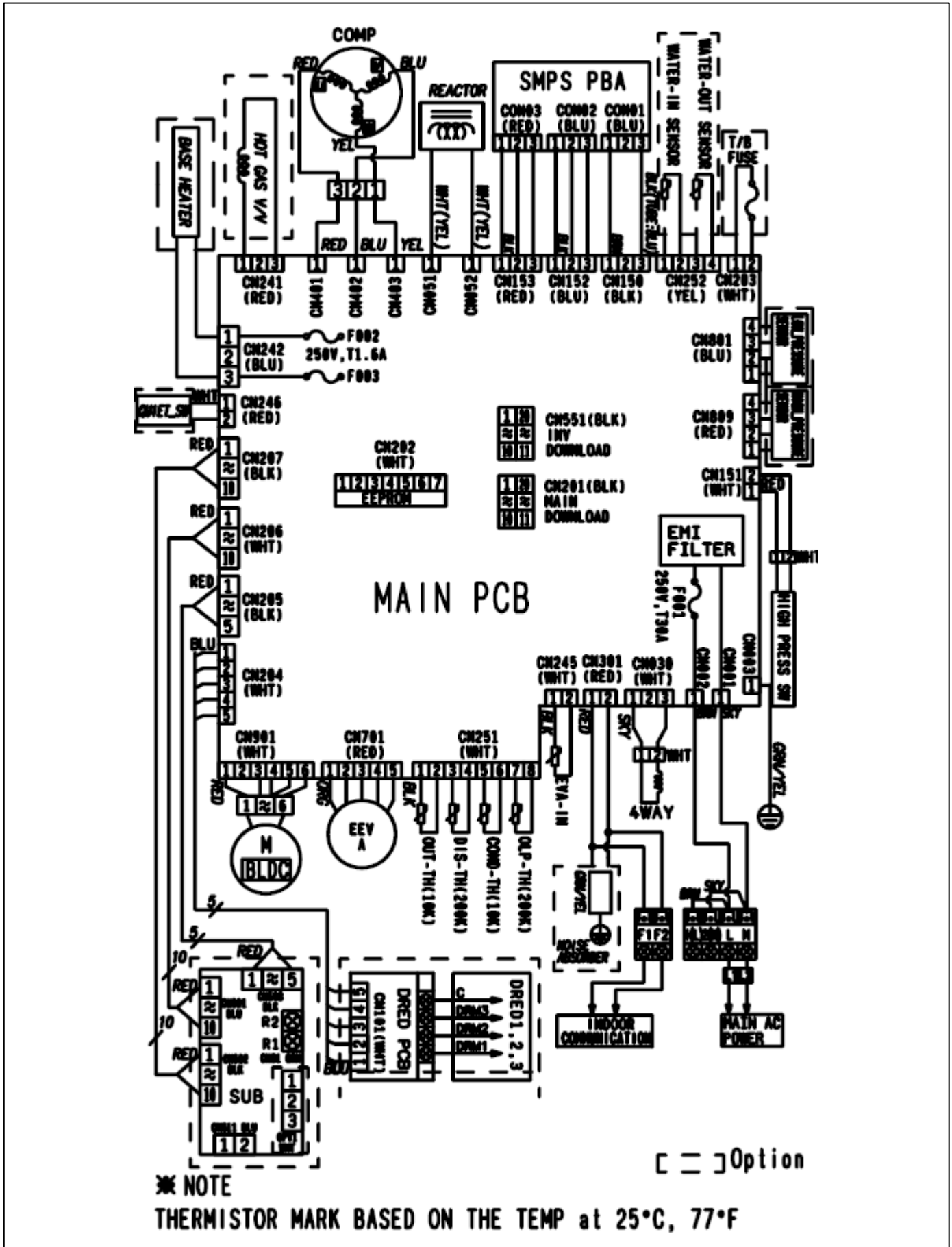

5. Wiring Diagrams

5-1. Outdoor Unit

2) AE090~160JXYDEH/EU

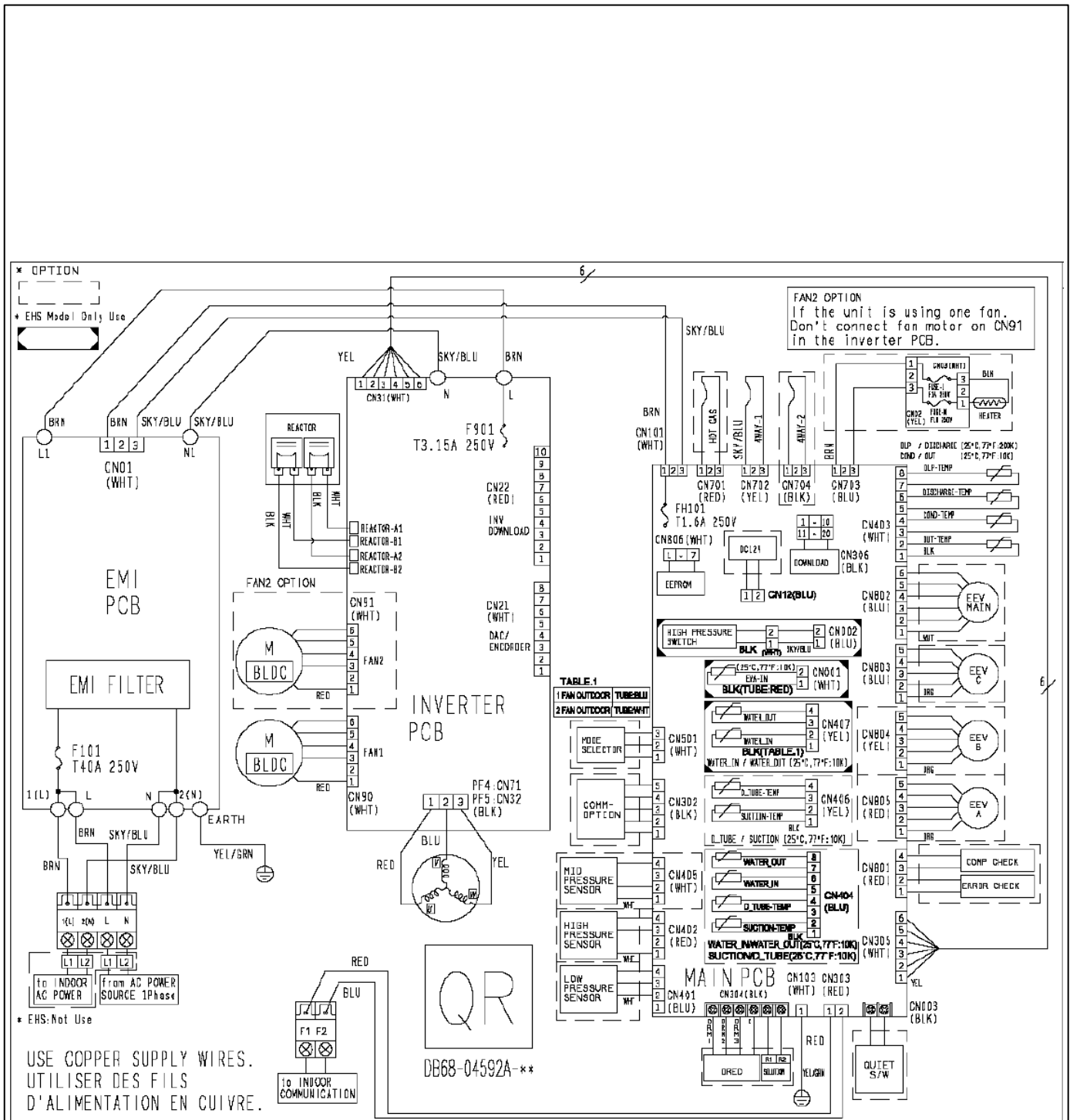

5. Wiring Diagrams

5-1. Outdoor Unit

3) AE090~160JXYDGH/EU

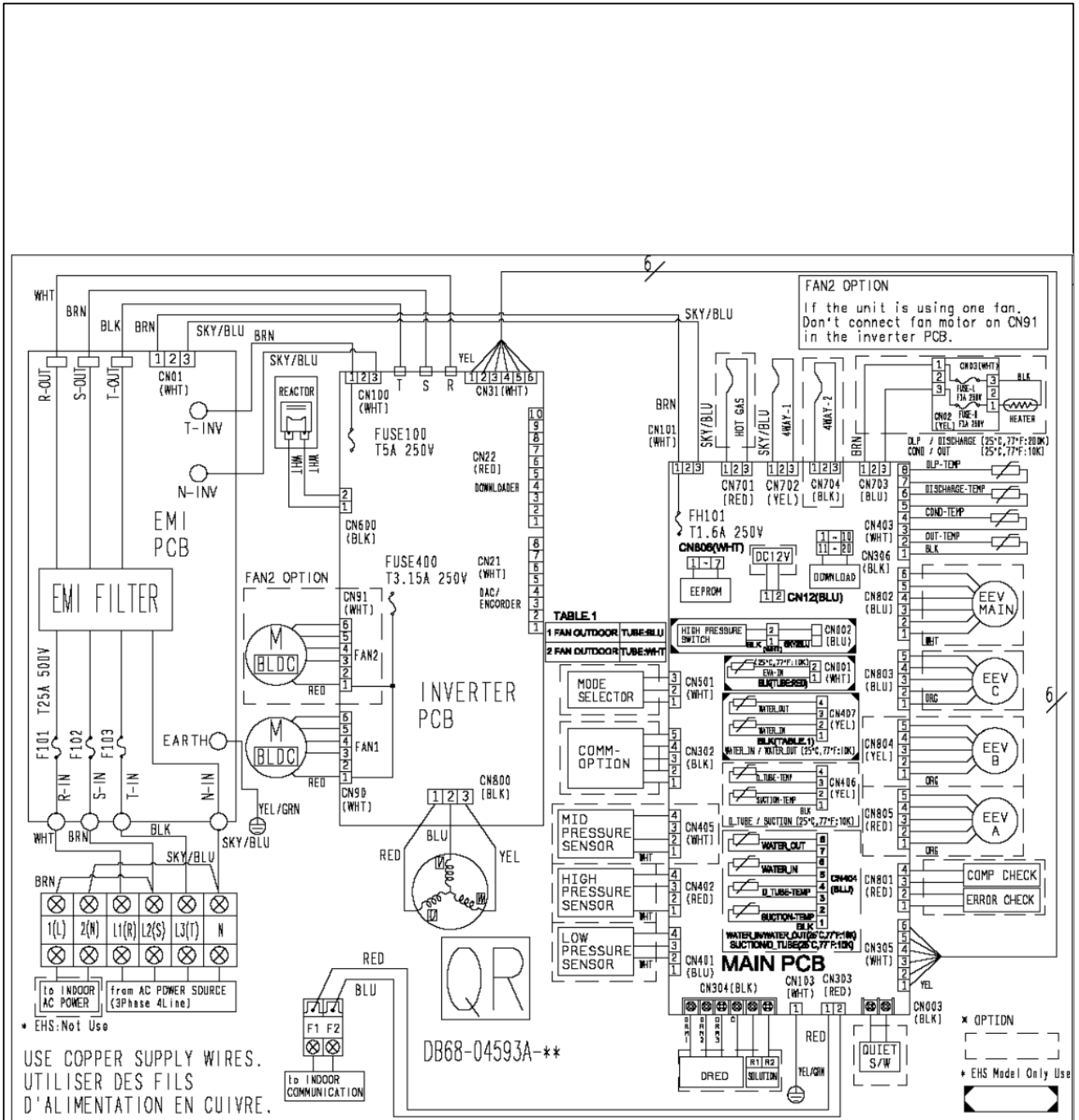

5. Wiring Diagrams

5-2. Control Kit

1) MIM-E03A(B)N

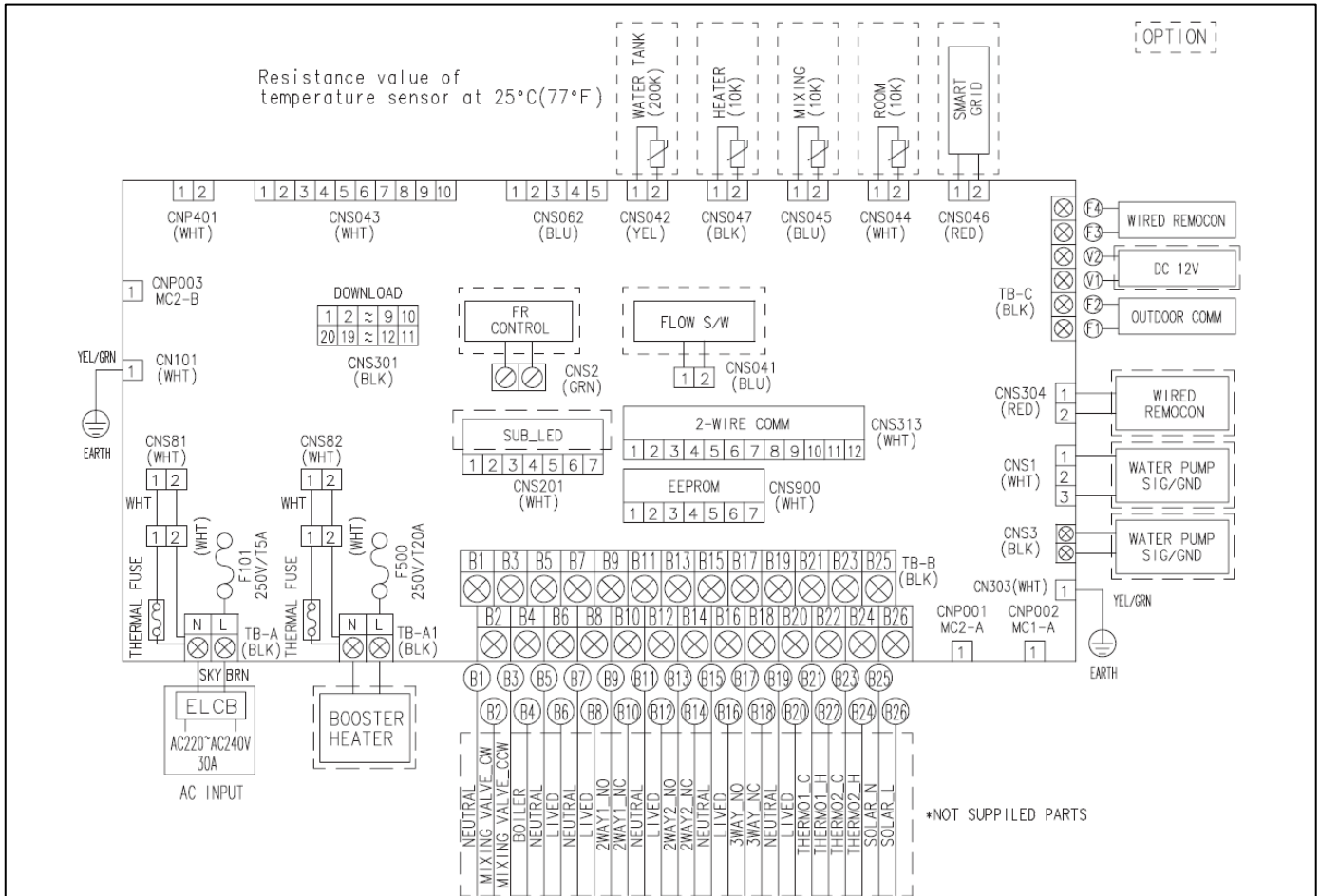

NO.	IN/OUT	CONNECTING PART	IN/OUT TYPE
TB-A	N	INPUT MAIN POWER	NEUTRAL
	L	INPUT MAIN POWER	LIVE
TB-A1	N	OUTPUT HEATER POWER	NEUTRAL
	L	OUTPUT HEATER POWER	SWITCHED LIVE
TB-B	B1	OUTPUT AC POWER-INV WATER PUMP	NEUTRAL
	B2	OUTPUT RELAY POWER-MIXING VALVE_CW	SWITCHED LIVE
	B3	OUTPUT RELAY POWER-MIXING VALVE_CCW	SWITCHED LIVE
	B4	OUTPUT RELAY POWER-BACKUP BOILER	SWITCHED LIVE
	B5	OUTPUT AC POWER-NEUTRAL	NEUTRAL
	B6	OUTPUT AC POWER-INV WATER PUMP	FUSED LIVE
	B7	OUTPUT AC POWER-AC WATER PUMP	NEUTRAL
	B8	OUTPUT AC POWER-AC WATER PUMP	SWITCHED LIVE
	B9	OUTPUT 2WAY VALVE 1_NORMAL OPEN TYPE	SWITCHED LIVE
	B10	OUTPUT 2WAY VALVE 1_NORMAL CLOSED TYPE	SWITCHED LIVE
	B11	OUTPUT AC POWER-2WAY VALVE 1,2	NEUTRAL
	B12	OUTPUT AC POWER-2WAY VALVE 1,2	FUSED LIVE
	B13	OUTPUT 2WAY VALVE 2_NORMAL OPEN TYPE	SWITCHED LIVE
	B14	OUTPUT 2WAY VALVE 2_NORMAL CLOSED TYPE	SWITCHED LIVE
	B15	OUTPUT AC POWER-3WAY VALVE	NEUTRAL
	B16	OUTPUT AC POWER-3WAY VALVE	FUSED LIVE
B17	OUTPUT 3WAY VALVE_NORMAL OPEN TYPE	SWITCHED LIVE	
B18	OUTPUT 3WAY VALVE_NORMAL CLOSED TYPE	SWITCHED LIVE	
B19	OUTPUT THERMOSTAT POWER	NEUTRAL	
B20	OUTPUT THERMOSTAT POWER	FUSED LIVE	
B21	INPUT COMMAND SIGNAL-ZONE.1 COOLING	SWITCHED LIVE	
B22	INPUT COMMAND SIGNAL-ZONE.1 HEATING	SWITCHED LIVE	
B23	INPUT COMMAND SIGNAL-ZONE.2 COOLING	SWITCHED LIVE	
B24	INPUT COMMAND SIGNAL-ZONE.2 HEATING	SWITCHED LIVE	
B25	INPUT SOLAR MODE SIGNAL-SOLAR PANEL OPERATION	SWITCHED NEUTRAL	
B26	INPUT SOLAR MODE SIGNAL-SOLAR PANEL OPERATION	SWITCHED LIVE	
TB-C	F1	COMM. COMMUNICATION LINE A-OUTDOOR UNIT	RS-485
	F2	COMM. COMMUNICATION LINE B-OUTDOOR UNIT	RS-485
	V1	OUTPUT DC12V	DC12V
	V2	OUTPUT GROUND	GROUND
	F3	COMM. COMMUNICATION LINE A-WIRED REMOTE C.	RS-485
F4	COMM. COMMUNICATION LINE B-WIRED REMOTE C.	RS-485	
CNS3	SIG	OUTPUT INV_PUMP_SIGNAL	DC SIGNAL
	GND	OUTPUT GROUND	GROUND
CNP002	MC1-A	OUTPUT BACKUP HEATER STEP 2	SWITCHED LIVE
CNP001	MC2-A	OUTPUT BACKUP HEATER STEP 1	SWITCHED LIVE
CNP003	MC2-B	OUTPUT AC POWER-BACKUP HEATER CONTROL	NEUTRAL CONTROL NEUTRAL
	1	OUTPUT AC POWER-BACKUP HEATER CONTROL	NEUTRAL NEUTRAL
CNP401	1	OUTPUT AC POWER-BACKUP HEATER CONTROL	NEUTRAL CONTROL NEUTRAL
	2	INPUT AC POWER-BACKUP HEATER CONTROL	NEUTRAL CONTROL NEUTRAL

6. Electric Specifications

6-1. Outdoor Unit

Product	Model Name	Rated		Voltage Range		MCA	MFA
		Hz	Volts	Min.	Max.		
Mono	AE050JXYDEH/EU	50	220-240	198	264	20.0	25.0
	AE090JXYDEH/EU	50	220-240	198	264	22.0	27.5
	AE120JXYDEH/EU	50	220-240	198	264	28.0	35.0
	AE014JXYDEH/EU	50	220-240	198	264	30.0	37.5
	AE160JXYDEH/EU	50	220-240	198	264	32.0	40.0
	AE090JXYDGH/EU	50	380-415	342	457	10.0	16.1
	AE120JXYDGH/EU	50	380-415	342	457	10.0	16.1
	AE014JXYDGH/EU	50	380-415	342	457	12.0	16.1
	AE160JXYDGH/EU	50	380-415	342	457	12.0	16.1

※ Notes

1. The power cable is not supplied with air conditioner.
2. Supply cords of parts of appliances for outdoor use shall not be lighter than polychloroprene sheathed flexible cord.
(Code designation IEC:60245 IEC 57 / CENELEC:H05RN-F)
3. This Equipment complies with IEC 61000-3-12.

※ Abbreviations

1. MCA : Min. Circuit Amps. (A)
2. MFA : Max. Fuse Amps. (A)

6-2. Control Kit

Product	Model Name	Load	Power supply	Power cable	Max. Length	Type GL
				mm ² , wires	m	A
Control Kit	MIM-E03AN MIM-E03BN	No Heater (Water Pump, Valve, Wired RMC)	1Φ, 220~240V, 50Hz	1.5 / 3	< 10m	10
				2.5 / 3	10m < L < 20m	10
		Booster Heater (3kW)		4.0 / 3	< 10m	20
				6.0 / 3	10m < L < 20m	20
		Booster Heater (~3kW) + Backup Heater (~3kW)		4.0 / 3	< 10m	40
				6.0 / 3	10m < L < 20m	40

※ Notes

1. The power cable is not supplied with the heat pump.
2. For power cable, use the grade H07RN-F materials in 1Ø system.
3. If you connect Backup Heater at separated power cable, you can reduce wire size.
(Please refer to indoor unit installation manual)

7. Sound Pressure Level

7-1. Operation Sound Level

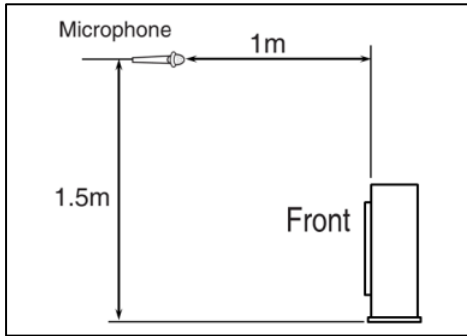

Model	Unit (dB(A))	
	Heating	Cooling
AE050JXYDEH/EU	45	45
AE090JXYDEH/EU	48	48
AE090JXYDGH/EU	48	48

7-2. NC Curve

1) AE050JXYDEH/EU

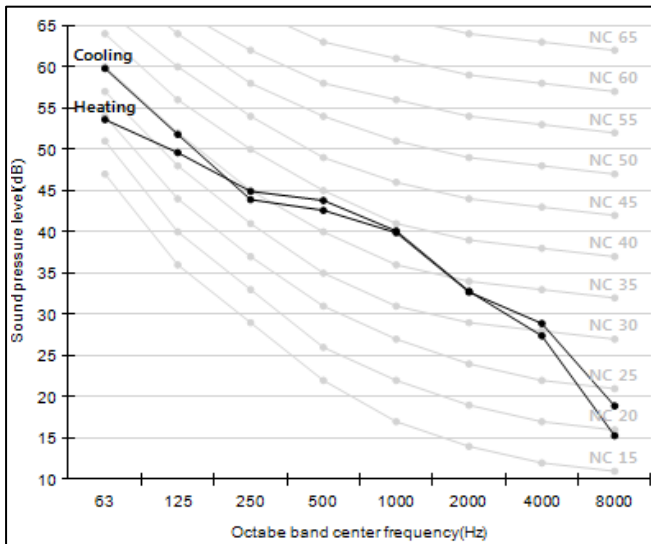

2) AE090JXYDEH/EU

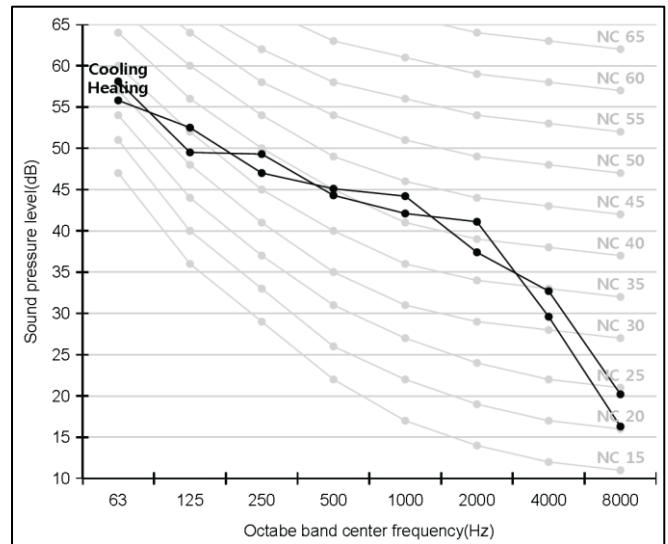

1) AE090JXYDGH/EU

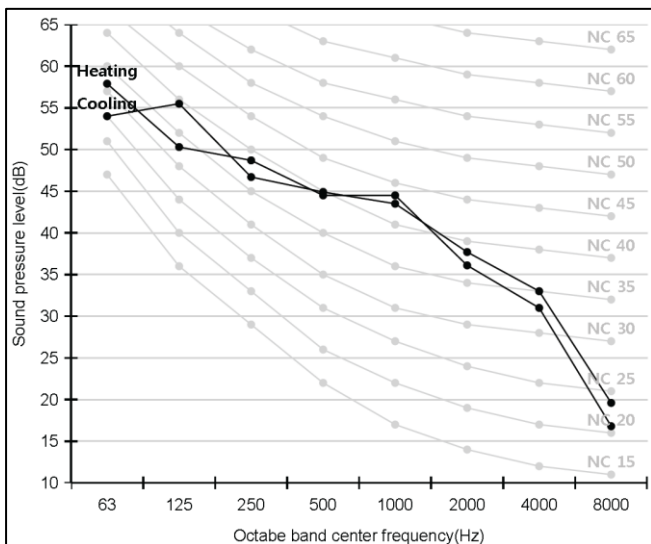

※ Notes

1. These operation values were obtained in an anechoic room. Sound pressure level will vary depending on a range of factors such as the construction of the particular room where the equipment is installed.
2. Operation sound level may differ depending on operation and ambient conditions.

7. Sound Pressure Level

7-1. Operation Sound Level

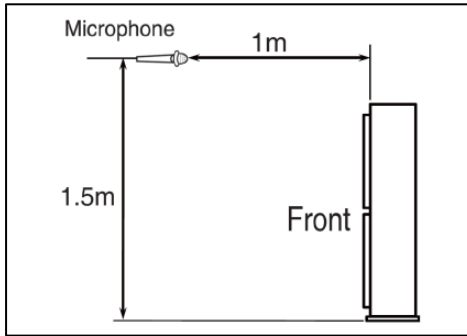

Model	Unit (dB(A))	
	Heating	Cooling
AE120JXYDEH/EU	50	50
AE120JXYDGH/EU	50	50
AE140JXYDEH/EU	51	52
AE140JXYDGH/EU	51	52

7-2. NC Curve

1) AE120JXYDEH/EU

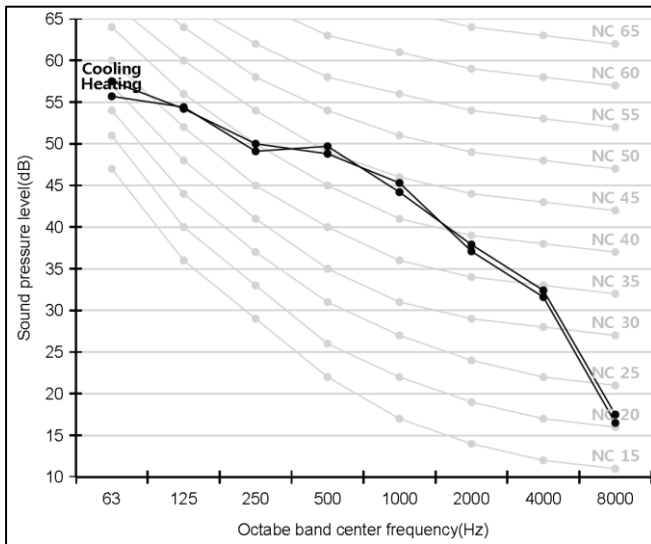

2) AE120JXYDGH/EU

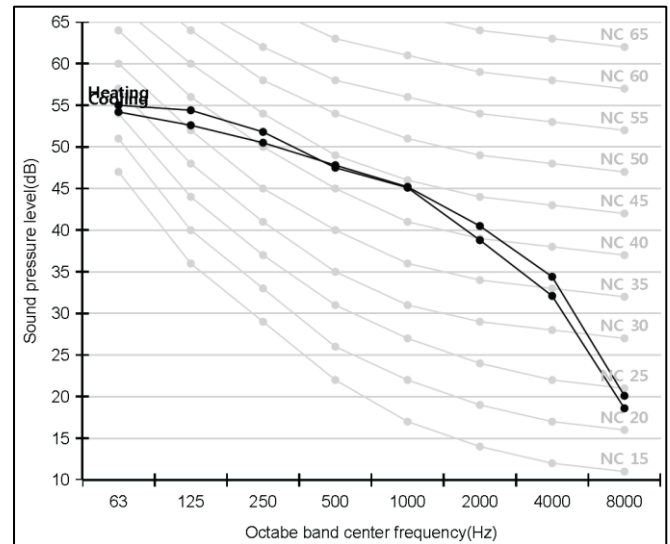

3) AE140JXYDEH/EU

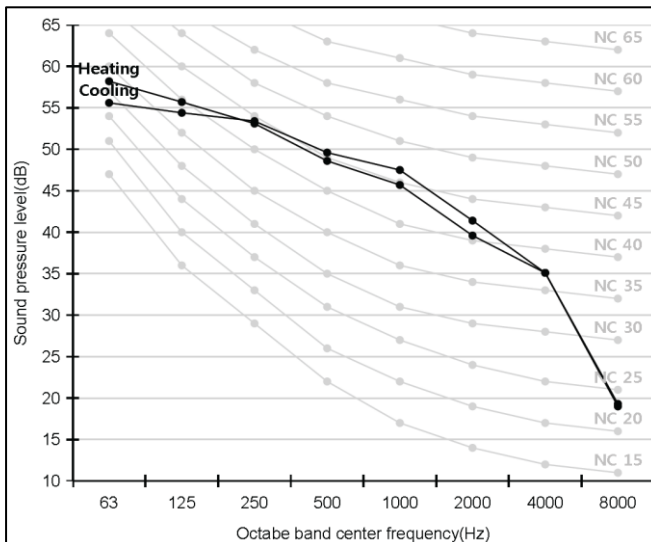

4) AE140JXYDGH/EU

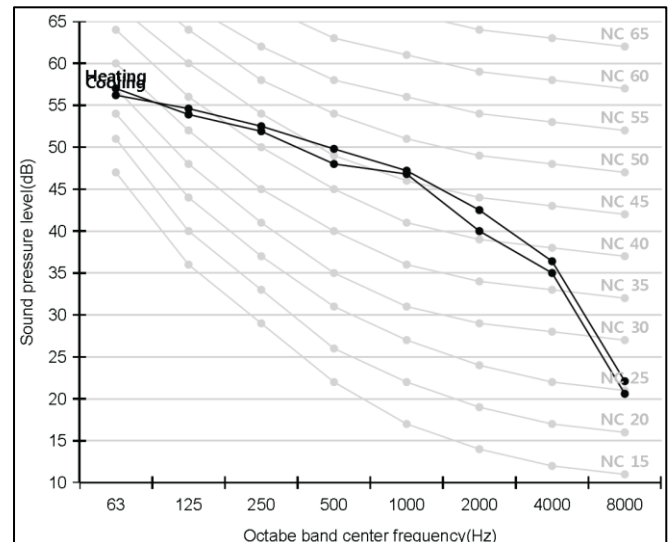

※ Notes

1. These operation values were obtained in an anechoic room. Sound pressure level will vary depending on a range of factors such as the construction of the particular room where the equipment is installed.
2. Operation sound level may differ depending on operation and ambient conditions.

7. Sound Pressure Level

7-1. Operation Sound Level

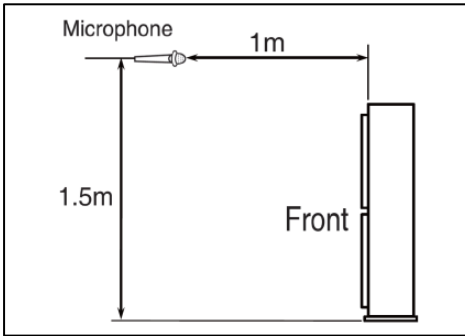

Model	Unit (dB(A))	
	Heating	Cooling
AE160JXYDEH/EU	52	54
AE160JXYDGH/EU	52	54

7-2. NC Curve

1) AE160JXYDEH/EU

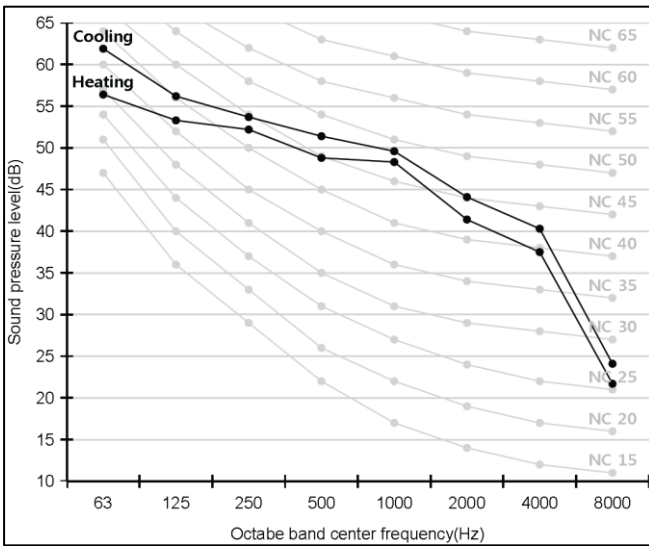

2) AE160JXYDGH/EU

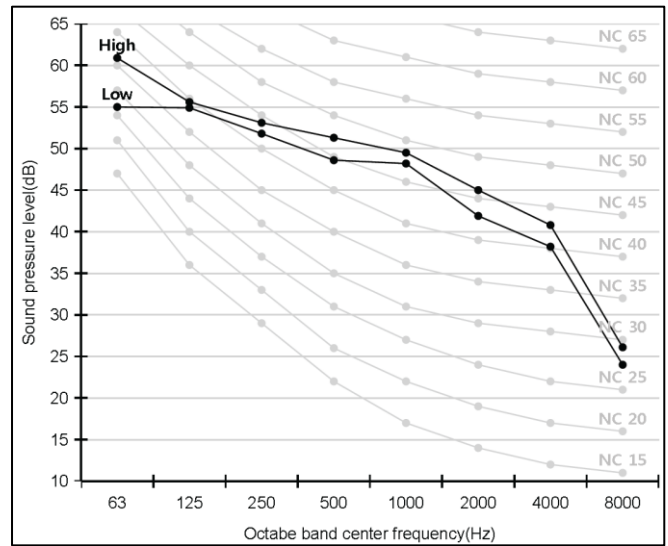

※ Notes

1. These operation values were obtained in an anechoic room. Sound pressure level will vary depending on a range of factors such as the construction of the particular room where the equipment is installed.
2. Operation sound level may differ depending on operation and ambient conditions.

8. Operation Range

8-1. Outdoor Unit

1) Cooling

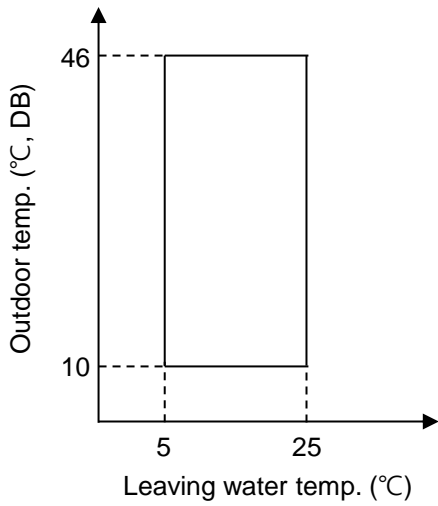

2) Heating

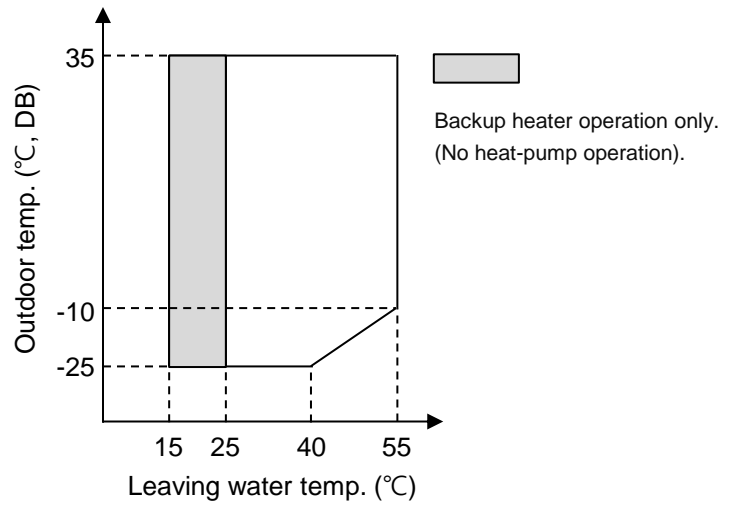

Outdoor Unit		Water Temp. (°C)			Water Flow Rates (LPM)			Air Temp. (°C, DB/WB)		
		Min	Std	Max	Min	Std	Max	Min	Std	Max
Controller	Cooling	5	-	25						
	Heating	15	-	55						
Cooling	Inlet	-	23 (12 ^{*3})	30	16 (7 ^{*1})	(Δ 5°C)	58 (42 ^{*2})	10/-	35/24	46/27
	Outlet	5	18 (7 ^{*3})	25				-25/-	7/6	35/24
Heating	Inlet	5	30 (40 ^{*3})	-						
	Outlet	25(15 ^{*4})	35 (45 ^{*3})	55						

*1) Figures in brackets are for 5kW model.

*2) Figures in brackets are for 5kW/9kW models.

*3) Figures in brackets are based on Eurovent Test Condition #2

*4) Figures in brackets are based on back up heater operation only.

3) DHW (Domestic Hot Water Tank)

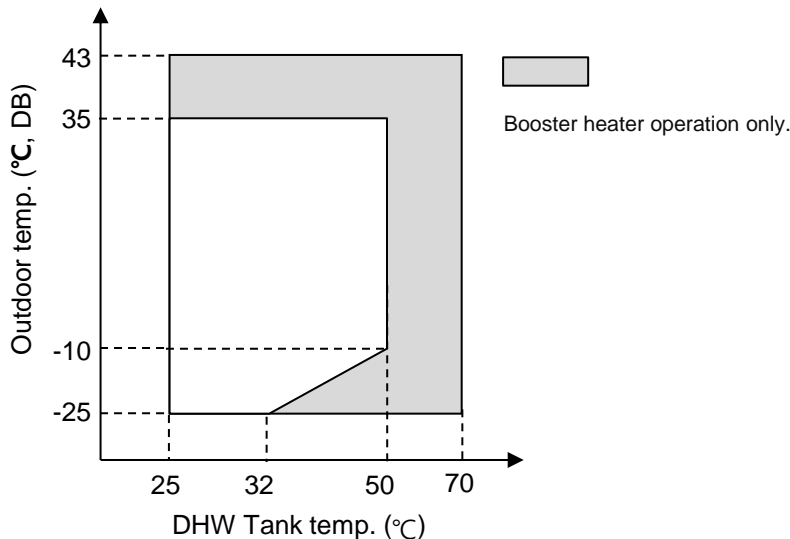

※ Special condition(35°C < Outdoor temp. ≤ 43°C) is operated by only Booster Heater.

SAMSUNG doesn't supply DHW for EHS Mono.

Since it is a reference data, you have to check DHW operation range for yours.

9. Hydraulic Performance

9-1. Correction Graph

1) AE050/090JXYD*H/EU

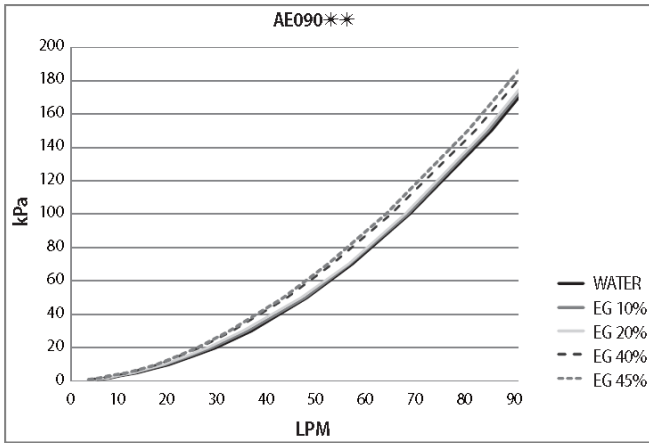

2) AE120/140/160JXYD*H/EU

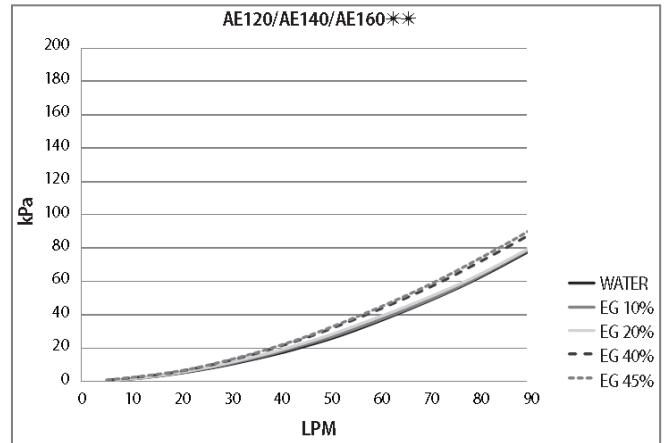

9-2. Capacity Correction

1) Heating

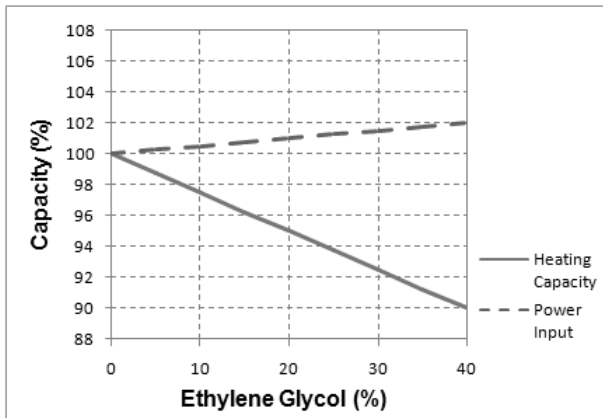

2) Cooling

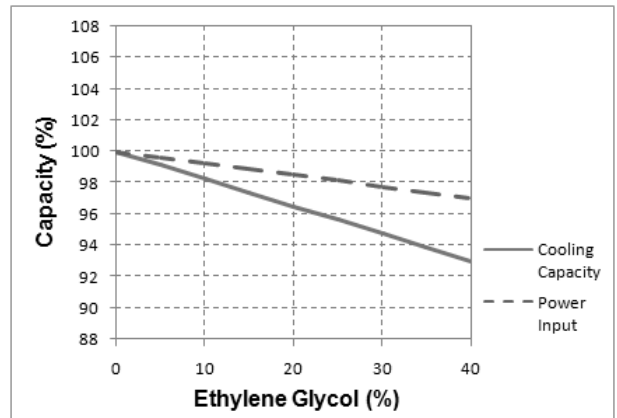

※ Notes

1. To ensure correct operation and predict the expected performance, this graph can be used.
2. Flow and resistance characteristic is dependent on anti-freezer concentration.
3. Tested with Ethylene Glycol.

※ Abbreviations

1. EG : Ethylene Glycol

III. Application

1. Application Examples

1. Application Examples

1-1. Outdoor Unit + Control Kit

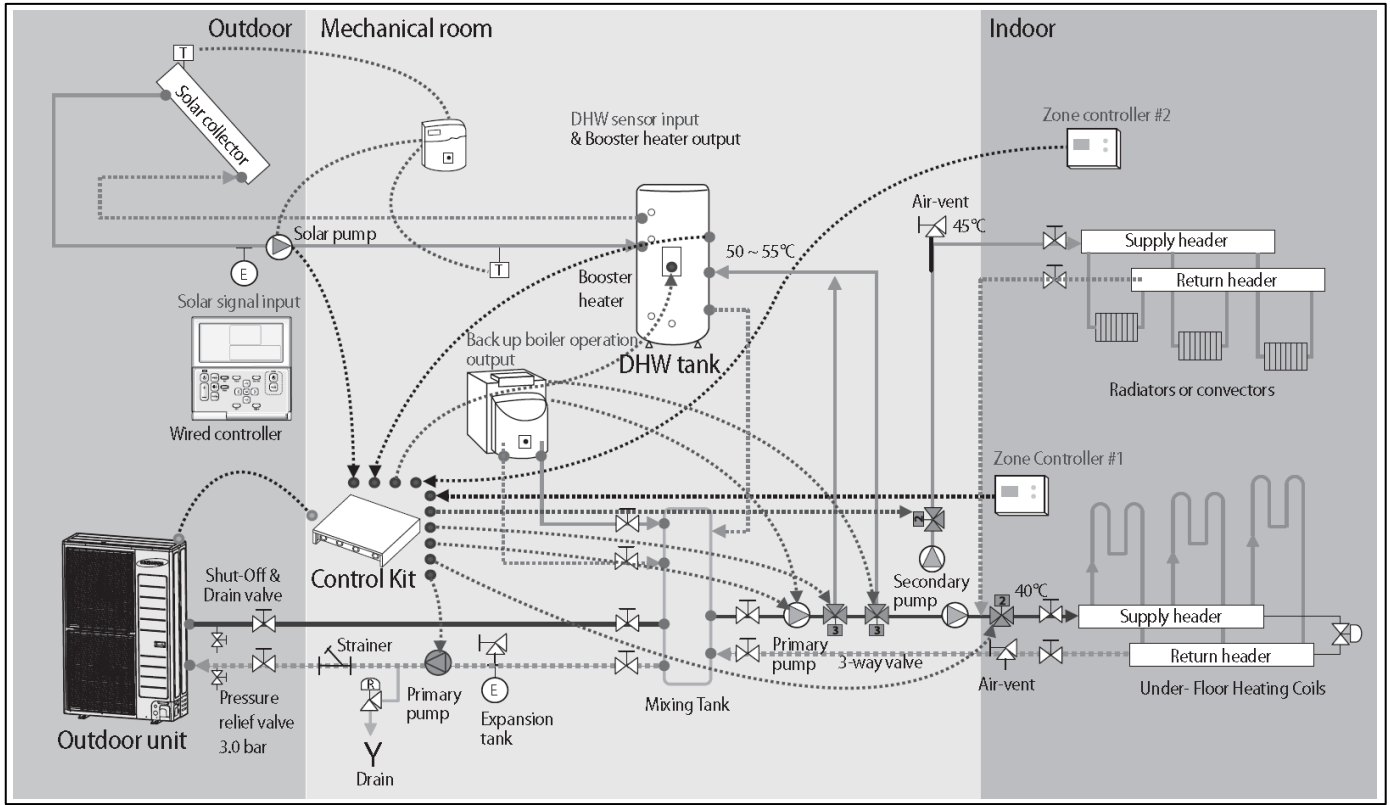

2) Outdoor Unit + Cylinder Unit

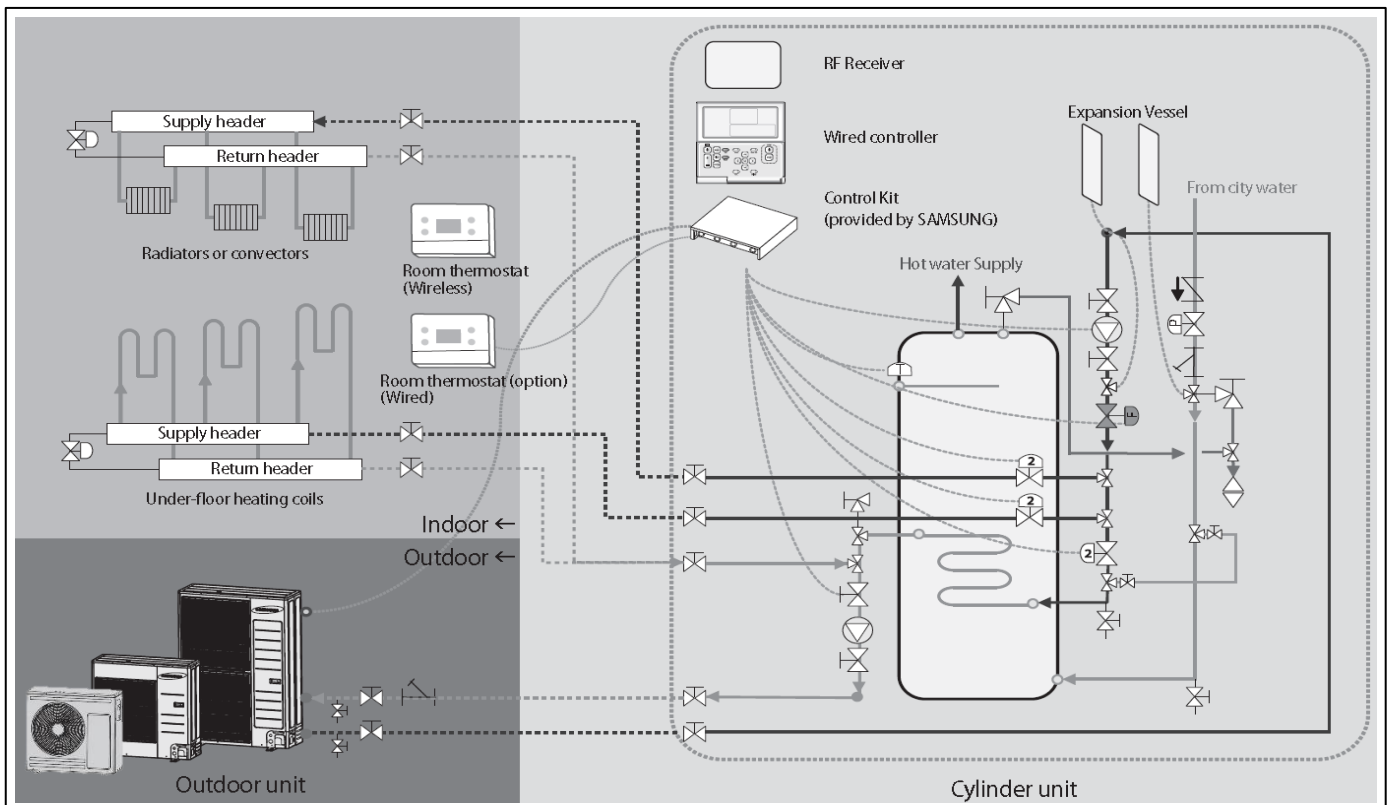

SAMSUNG

Samsung Electronics Co., LTD.
B2B PM / SE

Head Office (Suwon Korea) 129, Samsung-Ro, Yeongtong-Gu, Suwon City, Gyeonggi-Do, Korea 443-742
Website : www.samsung.com Email : airconditioner@samsung.com
Images and data in this book may subject to change without prior notice.

SAMSUNG