



**TECHNICAL MANUAL**

## ***Solar collector***

*Installation, maintenance & use instructions*



## CONTENTS

GENERAL INFORMATION.....	4
DOMESTIC HOT WATER CONSUMPTION .....	4
SOLAR WATER HEATER OPERATION - WATER HEATING.....	4
COLLECTOR AELIOS SPECIFICATIONS.....	5
PACKAGING .....	7
TRANSPORTATION AND HANDLING INSTRUCTIONS.....	7
LABELING.....	7
INSTRUCTIONS FOR THE INTERCONNECTION OF COLLECTORS IN SOLAR FIELDS.....	7
RECOMMENDATIONS ON HEAT TRANSFER MEANS AND SAFETY AND PROTECTION MEASURES DURING FILLING, OPERATION AND MAINTENANCE OF THE SYSTEM .....	7
MAXIMUM OPERATING PRESSURE, PRESSURE DROP, MAXIMUM AND MINIMUM ANGLE.....	8
GENERAL INSTALLATION RULES .....	9
INSTALLATION POSITION .....	10
GENERAL PREVENTION MEASURES.....	11
LIGHTING PROTECTION.....	11
SUPPORT BASE PARTS .....	12
SUPPORT BASE ASSEMBLY ON A FLAT SURFACE.....	15
SUPPORT BASE ASSEMBLY ON AN INCLINED SURFACE.....	17
POST INSTALLATION INSTRUCTIONS.....	19
CHECK LIST .....	20

## GENERAL INFORMATION

**In the present manual you will find all necessary instructions with regard to the installation, operation and maintenance of the product.**

The company is active in the Solar Energy Field with high-tech equipment, ultra-modern facilities and certified products of high quality. Our experience and know-how support our co operations, before and after sales, both in Europe and internationally.

Nowadays, the necessity for production and saving of energy without at the same time polluting the environment has become common knowledge. The planet's conventional energy resources are diminishing to a threatening level as our society's energy requirements are increasing, generating pollutants that affect the climate's balance. Renewable energy sources promise a solution to the energy problem as well as to pollution. Gradually, the international legislation is changing and encouraging - or even imposing - the use of alternative energy products, with the aim to satisfy energy requirements without endangering the environment.

## DOMESTIC HOT WATER CONSUMPTION

Statistically, it is estimated that the mean family consumption is 35 to 50 litres daily per person. If we add the consumption of a washing machine and a dishwasher, when these are connected to the solar water storage tank, then each requires 20 litres per day (per wash). Thus, a family of four, for example, with a mean hot water consumption of 40 litres per person, needs an 160 litres solar water heater. If household appliances connected to the solar water heater are added, then the demand increases by at least 40 litres daily. In order to take full advantage of the solar water heater, maximum use of hot water should be made during daytime, so that the system can continuously produce hot water during the daylight hours, maintaining thus its maximum efficiency.

## SOLAR WATER HEATER OPERATION - WATER HEATING

The collecting surface absorbs solar energy and heats the liquid (water or antifreeze mixture) that circulates in the water element. This liquid when heated becomes lighter and is directed to the water storage tank where it heats the water.

The factors that affect the temperature of the water supplied by a solar system are many and their values vary according to the season, the time of day and the location. Keeping in mind that the solar system is a system that is exposed to the weather conditions, basic parameters affecting its performance are the mains water temperature, the available solar energy and the ambient temperature. The mains water does not have a constant temperature throughout the year, being much colder in winter compared to summer. Considering 45°C as a satisfactory temperature for the domestic hot water (in order to fulfil the needs of a home) and based on statistic values, in winter the temperature of the mains water has to be increased by approximately 35°C, whereas during the summer the increase is 20°C. Similarly, the available solar energy does not remain the same throughout the year, being much less in the winter months than in the summer months. During periods of reduced sunlight and low ambient temperatures, the solar water storage tank assures the preheating of the water and is assisted by an electrical heating element or the central heating water storage tank (triple action solar water storage tanks). As far as night-time temperature losses are concerned, these are limited as much as possible by the solar system's powerful thermal insulation. They are nevertheless affected by ambient temperatures, which vary depending on the location and the weather.

## COLLECTOR SPECIFICATIONS

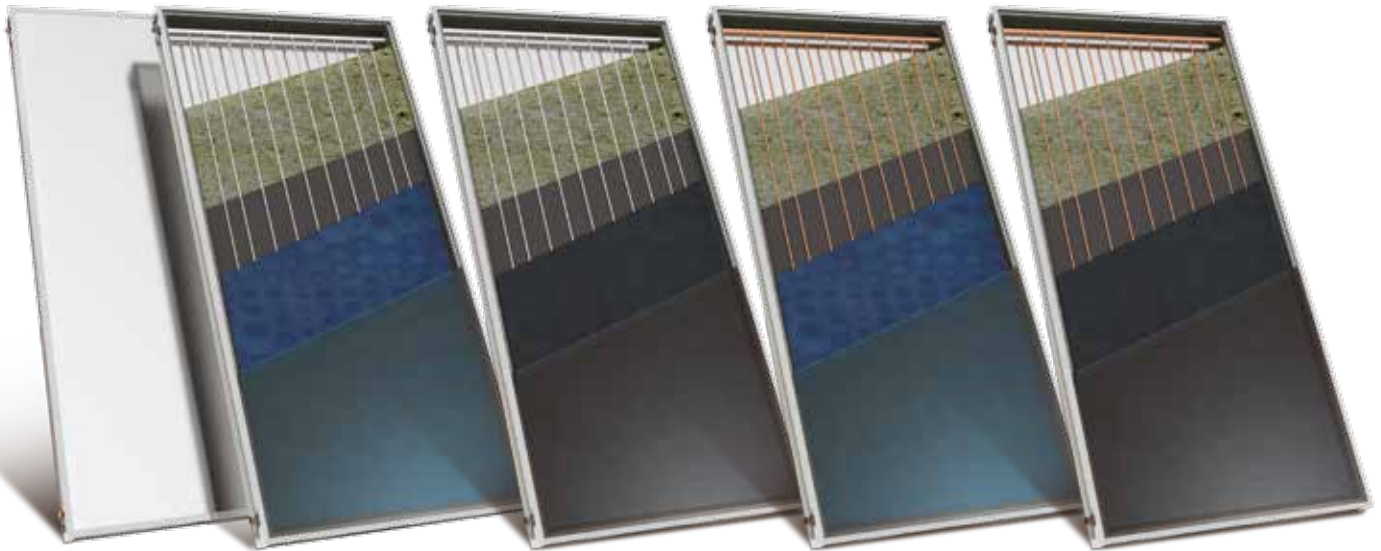

1. **Collector frame** of aluminium profile (Al Mg Si 05).
2. **Rear cover** of galvanized steel 0.5mm thick, tightly fitted with elastic EPDM seal.
3. **Water frame** of suitable gauge and thickness: Headers are punched with upper expansion, for perfect manifolds fitting, thus avoiding pressure drop in the collectors.

Tube pitch = 107mm (EN 1652)

**Copper water frame: Ø22 headers:** solar collector feed and feed-back. **Ø8 manifolds:** solar collector thermoabsorption for the AELIOS CuS and AELIOS CuB models.

**Aluminium water frame: Ø22 headers:** solar collector feed and feed-back. **Ø10 manifolds:** solar collector thermoabsorption for the AELIOS ALS and AELIOS ALB models.

4. **Complete area absorber** made of black painted aluminium 0.3mm thick, or selective aluminium 0.4mm thick, covers the complete window area as well as the headers, thus increasing the collector's absorptency, Laser Welded to the water frame.
5. **High density, eco-friendly thermal insulation** achieved with a 50mm and 20mm (back and lateral) thick layer of prepressed glasswool for the minimization of thermal losses.  
Glasswool insulation thermal conductivity:  $\lambda=0.032$  W/m grd (DIN 56612, measured at 0°C)
6. **Tempered solar glass**, with a stable coefficient of expansion and high light transmittance, can withstand adverse weather conditions (e.g. hail storm, extreme temperature changes, etc.). ANSI Z 97-1 (U.S.A.) BS 6206 (G.BRITAIN) DIN 52337 (GERMANY).

COLLECTOR				
TOTAL AREA (m <sup>2</sup> )	1.58	1.58	1.58	1.58
NUMBER OF MANIFOLDS	8 (Ø10)	8 (Ø10)	8 (Ø8)	8 (Ø8)
HEAT TRANSFER MEDIUM	PROPYLENE GLYCOL SOLUTION			
CAPACITY (lt)	1.14	1.14	1.12	1.12
ABSORBER SURFACE (m <sup>2</sup> )	1.33	1.33	1.33	1.33
TOTAL DIMENSIONS LxWxH (mm)	1530x1030x80	1530x1030x80	1530x1030x80	1530x1030x80
COLLECTOR TOTAL WEIGHT (without liquid) (kg)	27	26.5	28	27.5
ABSORBER	SELECTIVE ALUMINIUM	BLACK PAINTED ALUMINIUM	SELECTIVE ALUMINIUM	BLACK PAINTED ALUMINIUM
ABSORBENCY / RADIATION COEFFICIENT	95% ±2% / 5% ±2%	90% ±2% / 84% ±2%	95% ±2% / 5% ±2%	90% ±2% / 84% ±2%

COLLECTOR	AELIOS ALS 2000	AELIOS ALB 2000	AELIOS CuS 2000	AELIOS CuB 2000
TOTAL AREA (m <sup>2</sup> )	2.09	2.09	2.09	2.09
NUMBER OF MANIFOLDS	8 (Ø10)	8 (Ø10)	8 (Ø8)	8 (Ø8)
HEAT TRANSFER MEDIUM	PROPYLENE GLYCOL SOLUTION			
CAPACITY (lt)	1.34	1.34	1.28	1.28
ABSORBER SURFACE (m <sup>2</sup> )	1.80	1.80	1.80	1.80
TOTAL DIMENSIONS LxWxH (mm)	2030x1030x80	2030x1030x80	2030x1030x80	2030x1030x80
COLLECTOR TOTAL WEIGHT (without liquid) (kg)	35.5	35	36.5	36
ABSORBER	SELECTIVE ALUMINIUM	BLACK PAINTED ALUMINIUM	SELECTIVE ALUMINIUM	BLACK PAINTED ALUMINIUM
ABSORBENCY / RADIATION COEFFICIENT	95% ±2% / 5% ±2%	90% ±2% / 84% ±2%	95% ±2% / 5% ±2%	90% ±2% / 84% ±2%

COLLECTOR	AELIOS ALS 2600	AELIOS ALB 2600	AELIOS CuS 2600	AELIOS CuB 2600
TOTAL AREA (m <sup>2</sup> )	2.6	2.6	2.6	2.6
NUMBER OF MANIFOLDS	11 (Ø10)	11 (Ø10)	11 (Ø8)	11 (Ø8)
HEAT TRANSFER MEDIUM	PROPYLENE GLYCOL SOLUTION			
CAPACITY (lt)	1.73	1.73	1.64	1.64
ABSORBER SURFACE (m <sup>2</sup> )	2.30	2.30	2.30	2.30
TOTAL DIMENSIONS LxWxH (mm)	2030x1280x80	2030x1280x80	2030x1280x80	2030x1280x80
COLLECTOR TOTAL WEIGHT (without liquid) (kg)	44	43.5	45	44.5
ABSORBER	SELECTIVE ALUMINIUM	BLACK PAINTED ALUMINIUM	SELECTIVE ALUMINIUM	BLACK PAINTED ALUMINIUM
ABSORBENCY / RADIATION COEFFICIENT	95% ±2% / 5% ±2%	90% ±2% / 84% ±2%	95% ±2% / 5% ±2%	90% ±2% / 84% ±2%

Note: All dimensions measured in mm



#### Normal absorber design with louvers.

Air turbulence increases heat loss

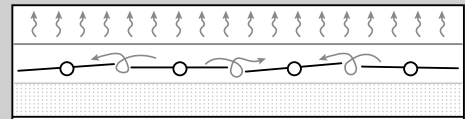

#### Complete area technology

The uniform area prevents heat loss

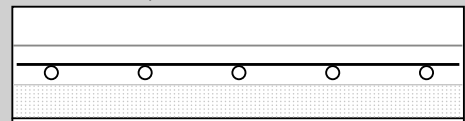

### SUPPORT BASE

One type of supporting base system made of 2.5mm thick galvanised steel for installation on flat or inclined surfaces

#### FLAT SURFACE



#### INCLINED SURFACE

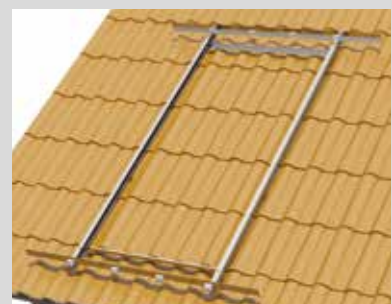

**NOTE:** Non-identical base for installation on flat or inclined surface in case of 5.2m<sup>2</sup> (2X2.6)

## PACKAGING

The collector is packed in a carton box. All the parts of the support base system, with the connection fittings, the antifreeze liquid and the other accessories are packed in a carton box.

## TRANSPORTATION AND HANDLING INSTRUCTIONS

**ATTENTION!** The supporting base must be assembled before the installation of the collector.

The collector is packed in a cardboard box. During its transport and handling, all safety indications on the packaging should be respected. The packing materials must be removed from the collectors at the point of installation, so as to protect them from shocks, paying attention not to support the collectors on their pipe connections. When the packaging materials are removed the collectors must be placed directly onto their supporting base, which must be assembled according to the instructions in this leaflet.

## LABELING

by two stickers, one of them on the tank and the other on the collector. On these stickers all the details of the system are written. The information provided on the stickers are important for the future identification of the system.

Type: Flatplate collector  
 Dimensions: (L x W x H) (mm): XXXX x XXXX x XX  
 Overall area (m<sup>2</sup>): XXX  
 Absorber area (m<sup>2</sup>): XXX  
 Total weight of collector (kg): XXX  
 Volume of heat transfer fluid (lt): XXX  
 Absorber coating: XXX  
 Standstill temperature: XXX°C  
 Max. operating pressure: 1.0 MPa (10 bar)  
 Transparent cover: Tempered solar glass  
 Heat transfer medium: Propylene glycol solution/water mixture



Licence No: XXX  
 S/N: XXX  
 Date: XX/XXX

**MADE IN EU**

## INSTRUCTIONS FOR THE INTERCONNECTION OF COLLECTORS IN SOLAR FIELDS

In a central collector bank, the maximum number of collectors, must not be greater than seven-eight (e.g. 14-16m<sup>2</sup>) per row. The collector banks must be connected in parallel between themselves and at a distance of 90cm (when at an angle of 25°) to 120 cm (when at an angle of 40°). At the beginning and the end of each line, there must be a valve and a 3/4" x 1/2" x 3/4" T-piece for the installation of a submersible thermometer. In addition at the end of the last row, the differential thermostat sensor must be placed in place of the collector's sensor (Ø8). The temperature difference of the differential thermostat must be set to 8°C, when the boiler sensor is at the top point and to 10°C, when the boiler sensor is at mid point. For example, for a 20m<sup>2</sup> bank of collectors (i.e. 10 collectors of 2m<sup>2</sup>) we recommend: 20m<sup>2</sup> x 40 lt/m<sup>2</sup>h = 800 lt/h and Ø18 diameter piping connecting the collectors to the boiler, insulated with the respective insulation.

## RECOMMENDATIONS ON HEAT TRANSFER MEANS AND SAFETY AND PROTECTION MEASURES DURING FILLING, OPERATION AND MAINTENANCE OF THE SYSTEM.

For the protection of the collectors' circuit from frost, a solution of water and propylene glycol is used, which is non-toxic, at a ratio suitable to provide frost protection down to -10° within the collector at an exterior temperature of -20°. Once the system has been placed and until the installation is complete the glass panels of the collectors must remain covered, until the boiler is filled with service water, so as to avoid the boiling of the filling liquid or the breakage of the glass. The system must have the filling liquid replaced or topped up every 2-3 years. The filling must be accomplished with a suitably diluted liquid. In addition, the circuit needs the provision of a differential thermostat with a sensor for the protection of the circuit from frost which shall activate the circulation pump when the internal temperature reaches +4°C. Additionally, under no circumstances must the automatic filling valve be left open, as there is the danger that if the collector bank has a small leak at some point which is leaking water, the automatic filling valve (if left open) will continuously top up the system with water and so the ratio of the anti freeze liquid will be altered and the collectors may break at the first sign of frost.

## MAXIMUM OPERATING PRESSURE, PRESSURE DROP, MAXIMUM AND MINIMUM ANGLE

The maximum operating pressure (taking into account the increase in pressure due to the water's expansion) must not exceed 400 kPa. The ideal water flow in a central system is 40 lt/m<sup>2</sup>h to 70 lt/m<sup>2</sup>h and the pressure drop per meter of installed pipe (supply and return to the collectors) is 30mm of water. This is the data that is used for calculating the dimensions of the circulation pump in each installation.

**NOTE:** To the pressure drop of 30mm of water per meter of installed pipe one must add 10mm of water per square meter of installed collector.

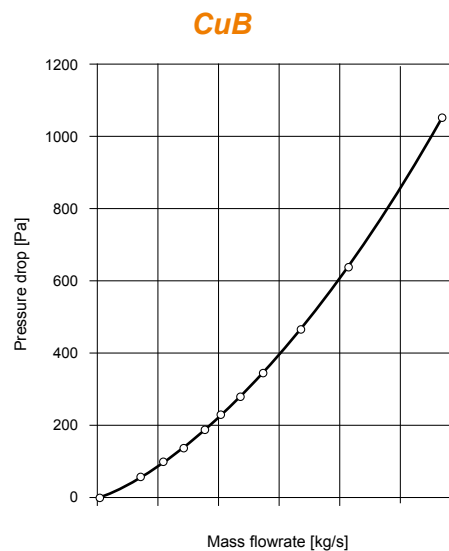
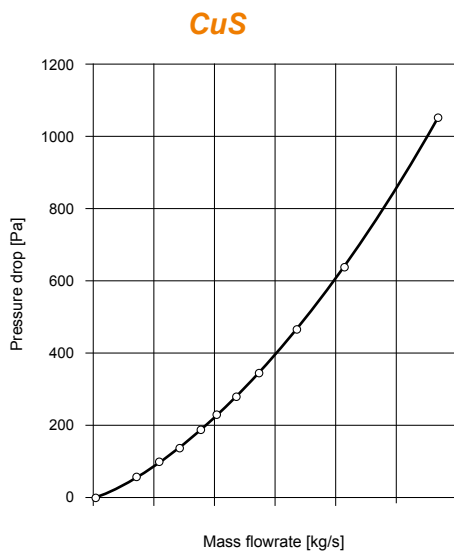
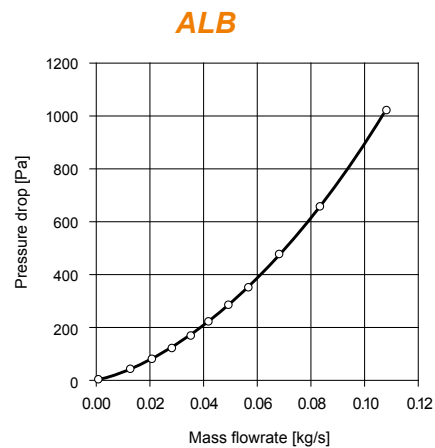
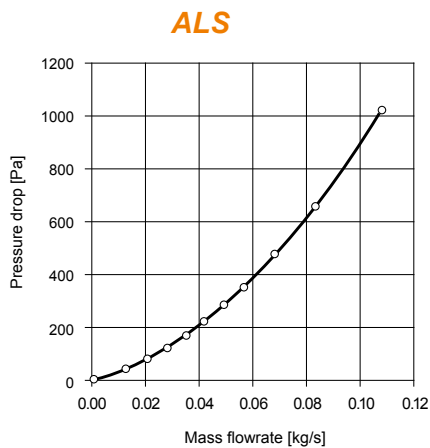

A basic factor in the optimum performance of the system is the correct selection of angle and orientation, in relation to the installation site and the period during which we want the maximum yield. The solar system must be oriented so that the collecting surface faces the geographical south for the northern hemisphere (and the geographical north for the southern hemisphere), i.e. it should always face the equator. Any deviation in the orientation means a drop in the system's performance. If a deviation from the correct orientation cannot be avoided, then the system's performance must be corrected by increasing the collector surface, after study and evaluation of the particular circumstances. As the solar radiation's angle of attack changes over time and in relation to the system's installation site, the collector's angle shall have to be equal to the site's latitude  $\pm 5^\circ$ . At this angle the maximum yield is achieved on an annual basis. The system must not be shaded by trees, buildings or other obstacles so as to ensure 4 hours of unimpeded exposure of the collector area during the midday hours.



## GENERAL INSTALLATION RULES

**ATTENTION:** Installation must be in compliance with local & national rules concerning water and electrical installations (plumbing, electricity, hygiene, urban and others).

**The solar system's packaging** must be removed at the site of installation in order to protect the device from shocks during its transportation, making sure that the collectors are not supported on their pipe joints. Until installation is completed, the collector's glass must remain covered until the water storage tank is filled with domestic water, so as to avoid the boiling of the filling liquid or the breaking of the glass. The plastic protective caps must be removed from the water storage tank's and the collector's pipe joints.

**Installation location - shading:** Prior to installation, a proper selection of the location must be made by the installer (in agreement with the customer), and the surface must be checked (taking into consideration its static resistance), so that it can bear the weight of the system.

On inclined roofs the system should not be placed between two beams but above a single one.

The position chosen for the solar water heater installation should not be shaded by any obstacles such as trees, buildings and other all year round, so as to ensure at least 4 hours of uninhibited exposure of the collector to the sun during the midday hours.

LATITUDE	DISTANCE BETWEEN THE OBSTACLE AND THE COLLECTOR (L)
0° - 25°	1.0 x H
26° - 35°	1.5 x H
36° - 45°	2.0 x H
46° - 50°	2.5 x H
> 50°	3.0 x H

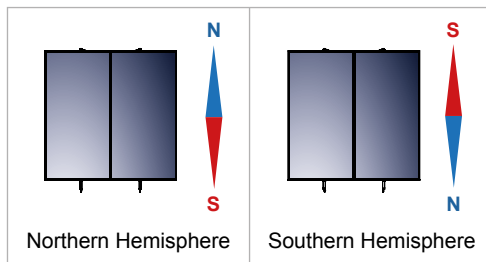
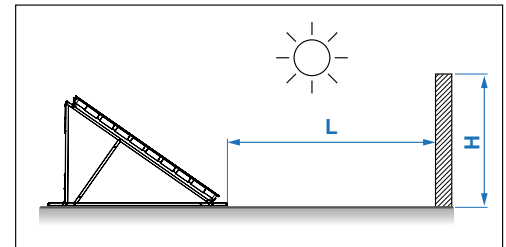

**Orientation - optimum angle:** a basic factor for the system's optimum performance is the selection of its angle and orientation for its particular location and the time during which the maximum gain is required. The solar system should be positioned so that the collector's surface faces the geographical south, if the installation takes place in the Northern Hemisphere (and the geographical north for the Southern Hemisphere), i.e. it should always face the Equator.

Any deviation means a reduction in the system's performance. If a deviation from the proper orientation cannot be avoided, then the system's performance should be corrected by increasing the collector surface, following a study and evaluation of the specific conditions that apply. As the sun ray's angle of attack varies with time but also depending on the system's location, the collector's angle should be approximately equal to the installation location's latitude. At this angle the maximum energy gain on an annual basis is achieved.

**Installation particularities:** In case there is no compatibility between the surface where the solar water heater will be installed (inclined or flat) and the standard equipment provided with the system, a different kind of equipment should be used. The responsibility for the equipment chosen lies on the installer and in no case on the company. It is up to the installer to propose & install the different equipment required, who must previously agree it with the customer.

**Special weather conditions:** In regions suffering from heavy snowfalls, please make sure that the snow is always timely removed. For this case and cases of regions with storms, high wind velocity, rainfall, cyclones, tornadoes, the system must be placed on the roof as firmly as possible and must be tightened with extra metal stripes. In areas where these conditions occur and hail of more than 20mm in diameter is to be observed, it is recommended that insurance for the solar water heater is issued. In every case, it is recommended to secure your solar water heater on the support base system with more metal belts than those provided.

**The systems shall not be used in climate zones with higher irradiation values than the values indicated below:**

COLLECTOR	AELIOS ALS	AELIOS ALB	AELIOS CuS	AELIOS CuB
MAX SOLAR IRRADIANCE ON COLLECTOR PLANE	21.21 MJ/m <sup>2</sup>	20.48 MJ/m <sup>2</sup>	21.97 MJ/m <sup>2</sup>	20.67 MJ/m <sup>2</sup>

**Piping:** the routing of the piping and cabling must be agreed upon between the installer and the client, so as to ensure the proper installation of the solar system in compliance with local rules concerning water and electrical installations. Make sure that the tubes connecting the storage tank with the collector and the piping to/from the water heater are insulated in such a way that they can withstand temperatures covering the range of: -30°C to 120°C. Anti-UV protection must be used for the insulation.

**Antifreeze Liquid:** The special heat transfer medium used in the closed circuit protects the system from freezing and from salt accumulation inside the collector tubes. The jacket in which the heat transfer medium's circulation takes place, does not communicate with the water tank. The thermal fluid must be well mixed with water in a percentage that is necessary to protect the system. The responsibility for the appropriate heat transfer medium quantity as well as for the use of other liquid than the one accompanying the solar water heater lies on the installer and in no case on the company. The use of water or inappropriate liquid may annul the warranty validity.

After the installation is completed, the area where the work was executed should be clean & tidy. The warranty should be filled in and the customer should sign it and immediately mail it to the company. The customer should fill in the check list provided by the company. The company does not hold any responsibility that may be the result of an inappropriate installation or incorrect use of components used for the solar water heater installation.

## INSTALLATION POSITION

The installation is only allowed on roofs and flat surfaces of adequate bearing capacity. Before you proceed with the installation, make sure that the roof and/or the construction is of adequate bearing capacity in terms of statics, always according to the expected maximum loads at the installation point. If the installation is in a place with an extremely big wind and snow load, the system as a whole should be statically checked by a skilled person, e.g a specialized engineer. In special cases, strengthening or more solid constructions may be required.

AELIOS COLLECTOR		
INSTALLATION MODE	WIND LOAD [km/h] / [kN/m <sup>2</sup> ]	SNOW LOAD [kN/m <sup>2</sup> ]
Inclined surface inclination angle: 15° – 75°	151 / 0.5	0.67
Flat surface inclination angle: 35°	151 / 0.5	0.67

The system may only be installed in locations with lower wind and snow load values than the ones mentioned above.

### Space requirements for installation on the roof (TILED ROOF)

For the installation on the roof the following points must be taken care of:

- The minimum distances from the ends of the roof should be:
  - From the sides: distance equal to the width of two tiles
  - From the top of the roof: distance equal to three rows of tiles
- The minimum distance limit of 0.8m should necessarily be respected, in order for the collectors and the mounting accessories not to be exposed to winds the power of which increases on the perimetrical edges of the roof.

### Space requirements for free standing installation (FLAT ROOF)

The system should be installed at least 1.5m away from the edges of the roof so as for:

- The systems to be accessible for maintenance reasons.
- The systems and the fixing system not to be exposed to strong winds which are developed at the ends and edges of the roof.
- The snow to be removed.

## GENERAL PREVENTION MEASURES

- Please respect the instructions related to accidents prevention and the safety rules during the installation of the solar thermal systems as well as the piping.
- Please keep the work place clear and free of objects obstructing the execution of works.
- Do not let children, pets and other people to come in contact with the tools or close to the working place. This has to be respected, especially in case of existing buildings renovation.
- Store the antifreeze liquid in a safe place away from children.
- During the execution of maintenance, service or installation modification works, please remove the electrical devices and tools current collector or protect the electrical devices and electrical tools against unintended activation.
- Use only the tools intended to be used for this specific solar system. The use of other components or inappropriate tools can cause accidents.

### *Requirements related to the personnel*

- The installation of our Solar Thermal systems can only be undertaken by authorized specialized companies and trained personnel.
- Works in electrical installations or conductors have to be executed by trained & specialized electro technicians only.

### *Labour uniforms*

- Have protection glasses on, as well as appropriate work uniform, protection shoes, protection helmet and special long hair net.
- Do not wear baggy clothes or jewelry, as they may be trapped in movable parts.
- If, despite the use of protection glasses, antifreeze liquid comes in contact with your eyes, wash off your eyes with plenty of water and with the eyes wide open.
- Please wear protection helmet during the installation works executed at the level of or above the head.

### *Installation of the water storage tank*

- For the transportation, mounting & installation of the tank use forklifts suitable for the dimension and weight of the tank.
- Please protect the enameling surface from beatings during transportation and installation.
- Due to the tank's weight, there is a risk of accidents. Please make sure that the bearing capacity of the ground where the tank is going to be installed is adequate, when the tank is full.

## LIGHTNING PROTECTION

The metal construction conforms to the general requirements of the ELOT 1197 Standard and the special lightning protection requirements of the ELOT 1412 Standard which takes into account the environmental conditions as well as the altitude.

# SOLAR COLLECTOR SUPPORT BASE PARTS

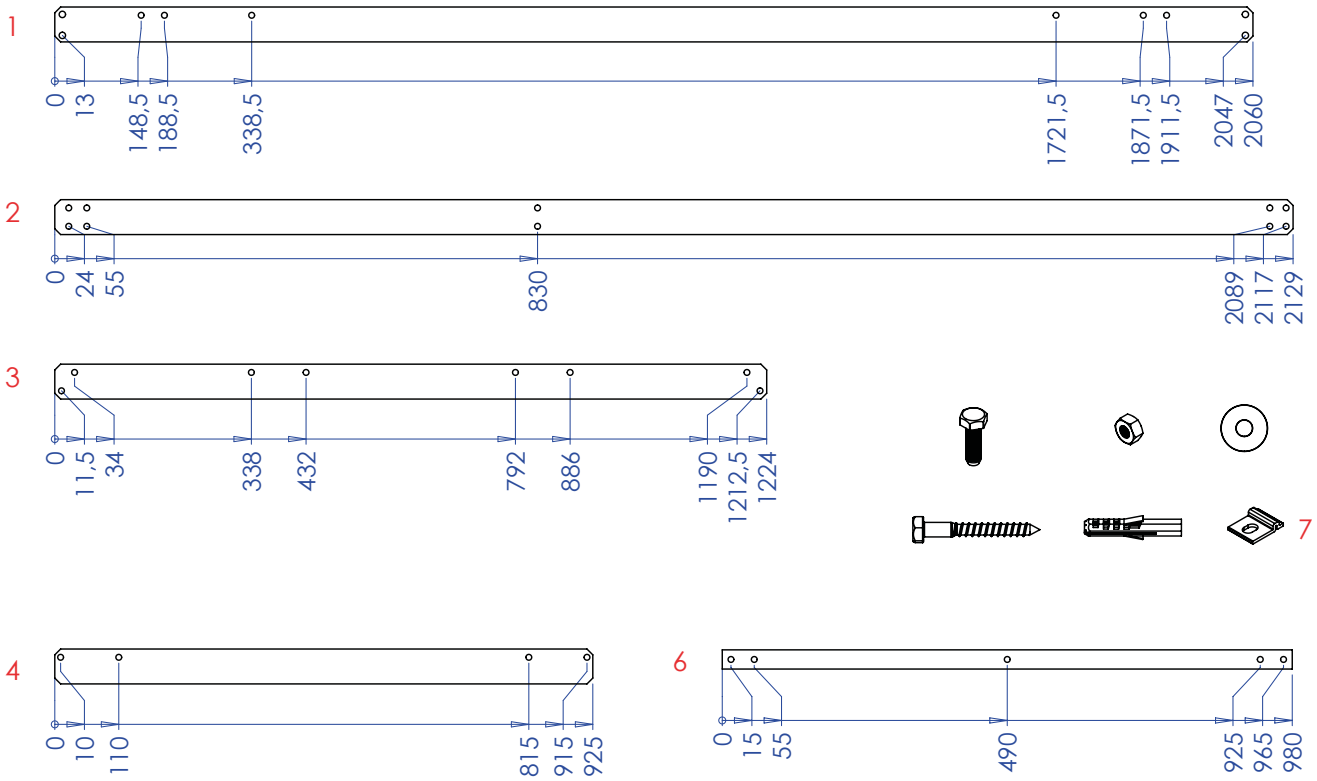

## For 2 collectors AELIOS 2000

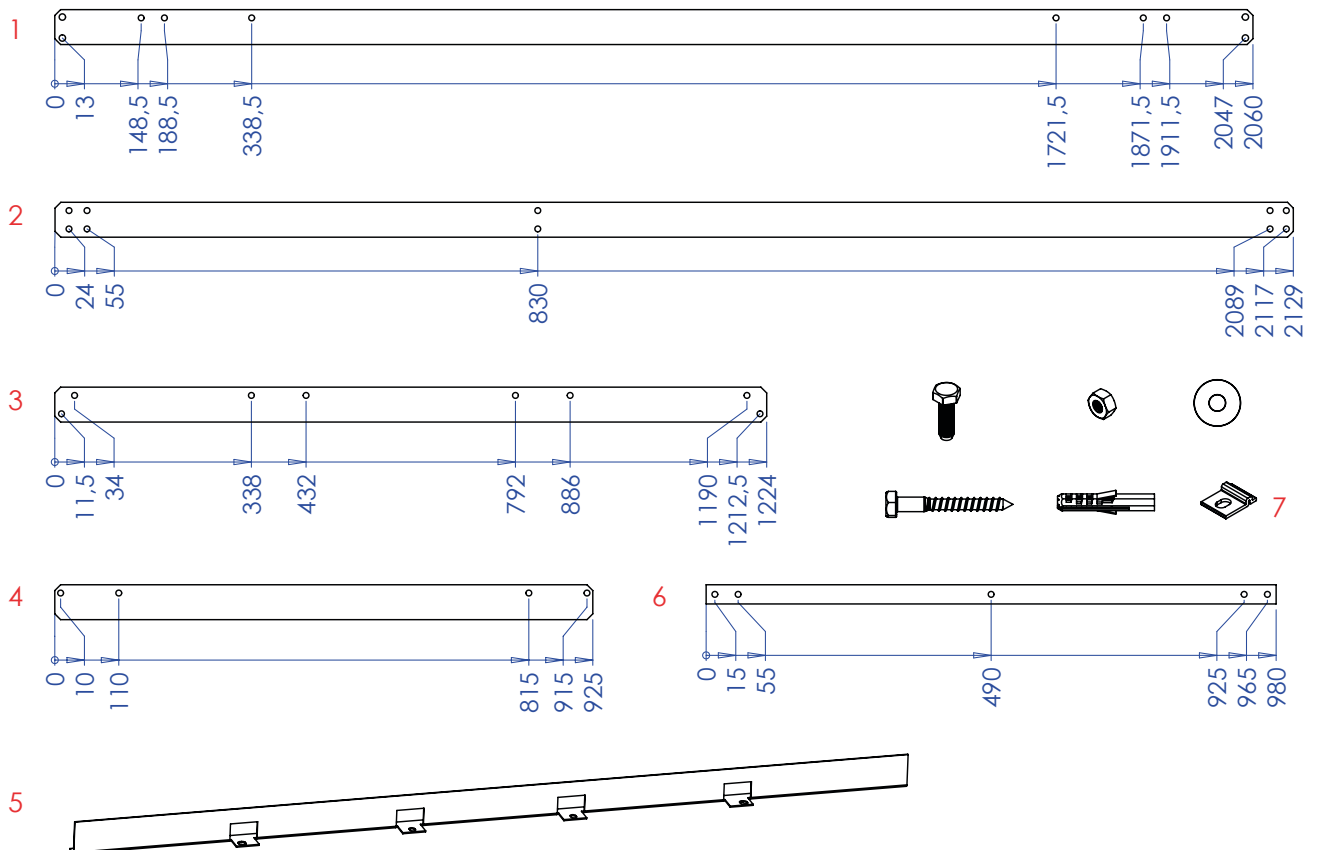

# SOLAR COLLECTOR SUPPORT BASE PARTS

For 2 collectors 2600

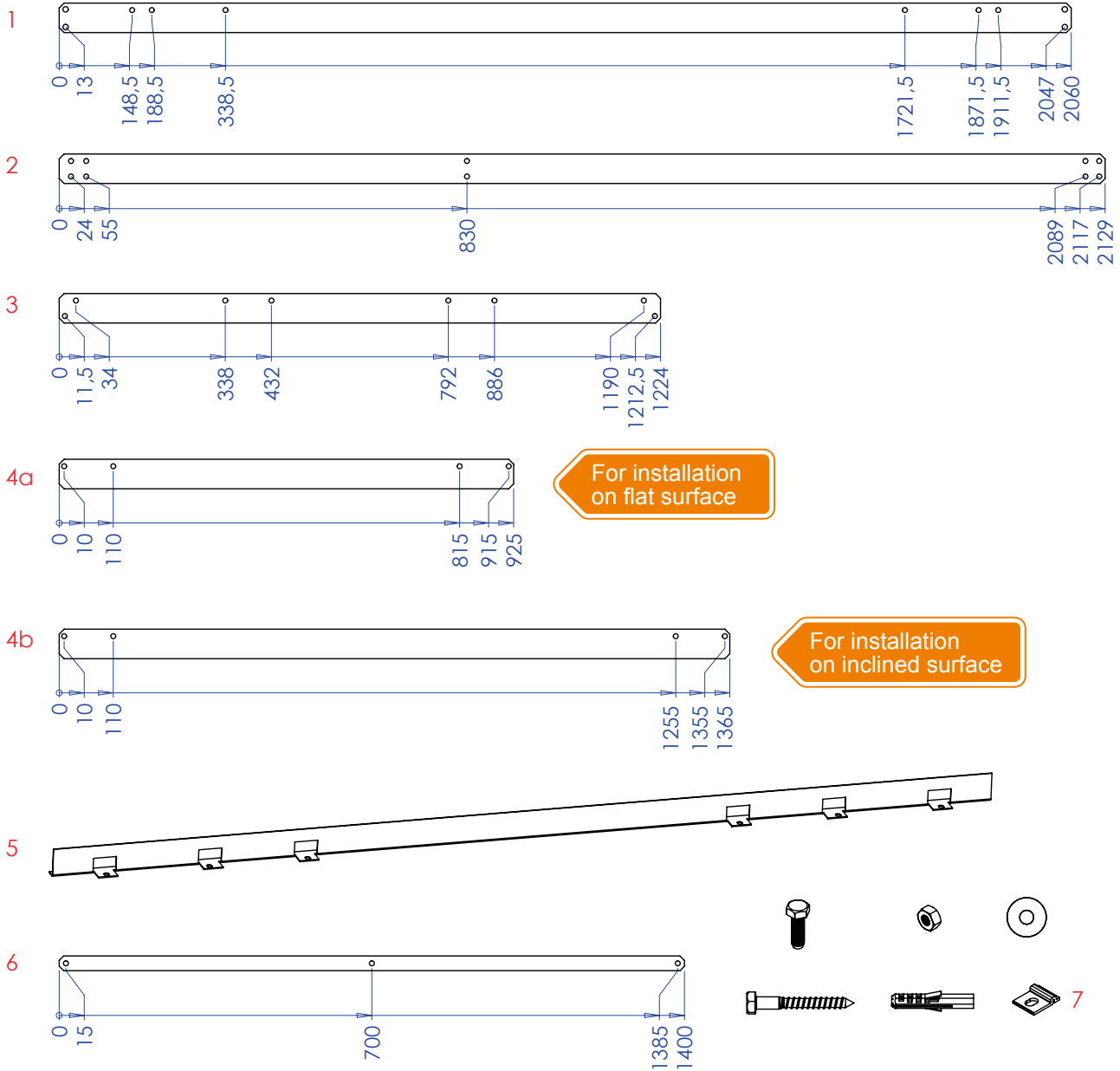

# SOLAR COLLECTOR SUPPORT BASE PARTS

For 1 or 2 collectors AELIOS 1500

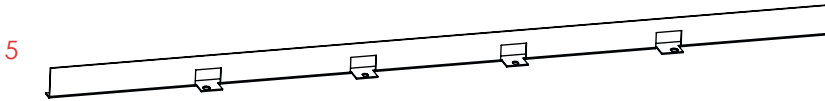
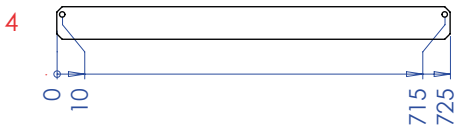
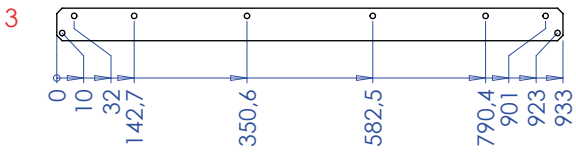
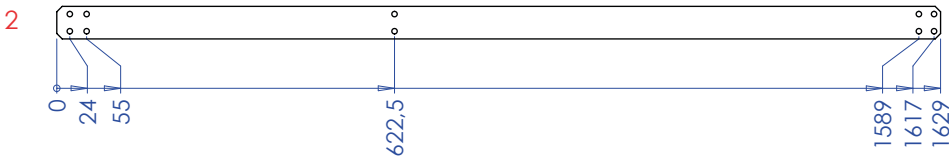
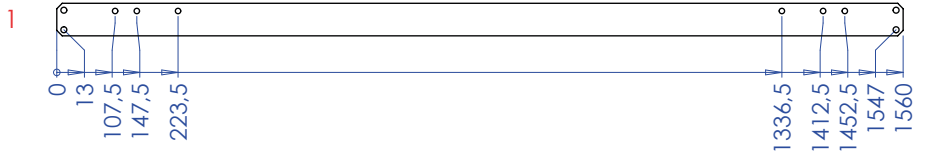

For 2 collectors installation

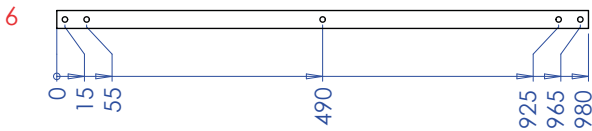

## SUPPORT BASE ASSEMBLY ON A FLAT SURFACE

1. Screw parts 1 to part 2, using the M8 screws and nuts included in the packaging.

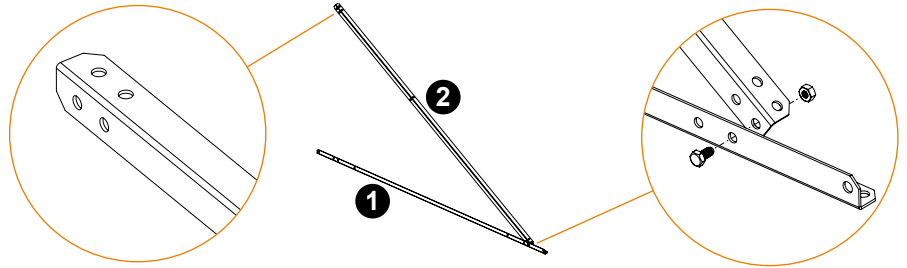

2. Screw vertical part 3 to the above parts.

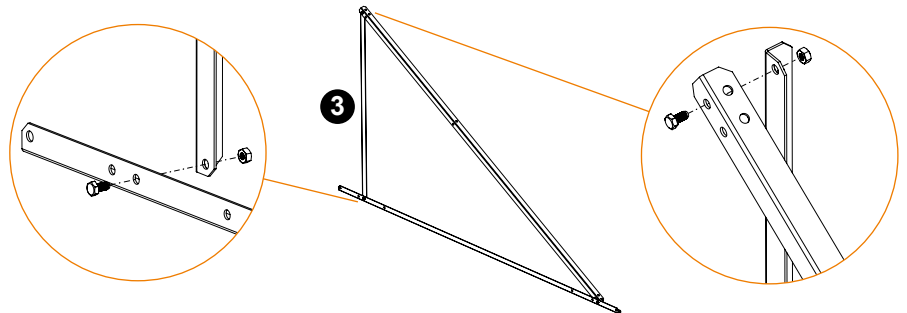

3. Screw diagonal part 4 to the above parts and tighten all screws. Repeat steps 1, 2 & 3 for the other pairs of parts.

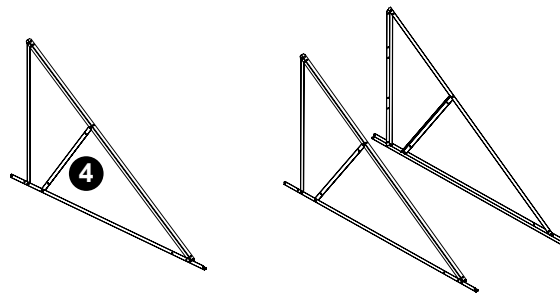

4. Place parts 6 crosswise and tighten the screws.

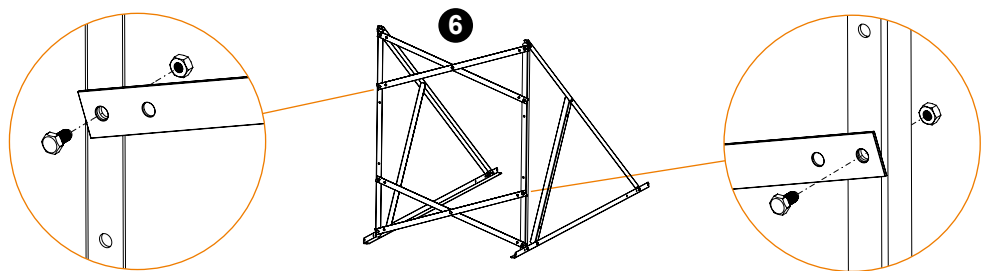

5. In case of two collectors model, place the collector supporting part 5 on bottom part and between the gaps of it we place the four collectors' fixing washers without tightening the M8 screws with the nuts. In case of one collector model you don't need to use part 5. The collector is going to be fixed with the 2 collectors' fixing washers as it is described at the 5a and 5b balloons.

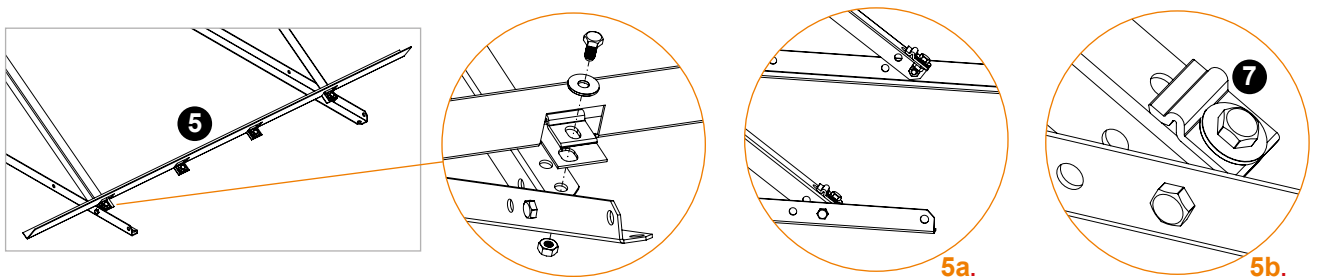

6. Repeat for the top part

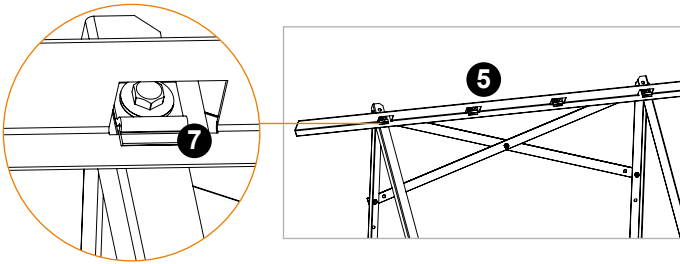

7. In case of two collectors, first place the left one, lifting the collector's upper and lower fixing washers 7. When the collector is placed under, we slightly tighten the M8 screws and nuts with the collector's fixing washers 7 in order to temporarily restrain it and easily center it with the system. Place the mechanically tightened unions Ø22 at the collector's edges.

8. Join the second collector and tighten the unions\*.



9. Tighten all screws on the base. Properly orientate the base with the collector. Firmly attach the base using 4 inserts and bolts (M8x60)

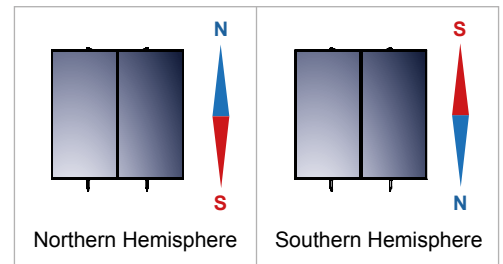
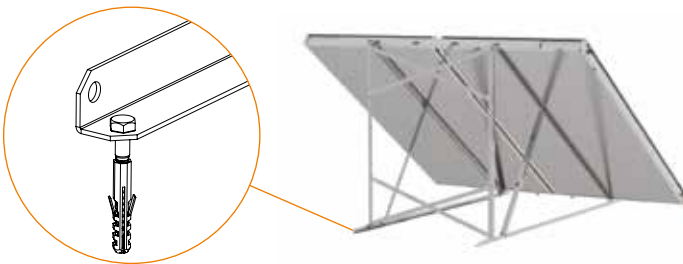

10. Place the T- piece with the air bleed and the sensor slot at the upper left part of the collector. Connect the pipeline to the inlet of the systems heat exchanger.
11. Place the 3/4" x Ø22 mechanically tightened plug at the collector bottom right edge for the connection of the boiler line\*. Connect the pipeline to the outlet of the systems heat exchanger.
12. Place and tighten the Ø22 mechanically tightened plug on the top right and on the bottom left of the collector/ collectors\*.

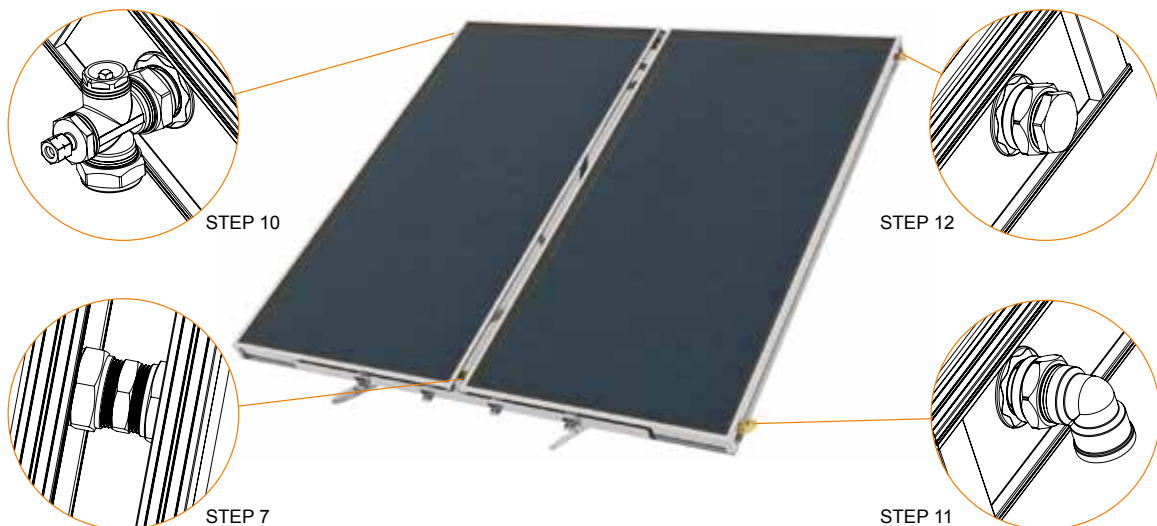

\*Use lock nuts in order to avoid the copper tube mechanical strain.



## SUPPORT BASE ASSEMBLY ON AN INCLINED SURFACE

**ATTENTION!** After the installation check that the collectors surface has a tilt angle to the horizontal position of geographical latitude  $\pm 5^\circ$ .

1. Screw part 1 to part 2, using the M8 screws and nuts included in the packaging. Repeat for the second pair.

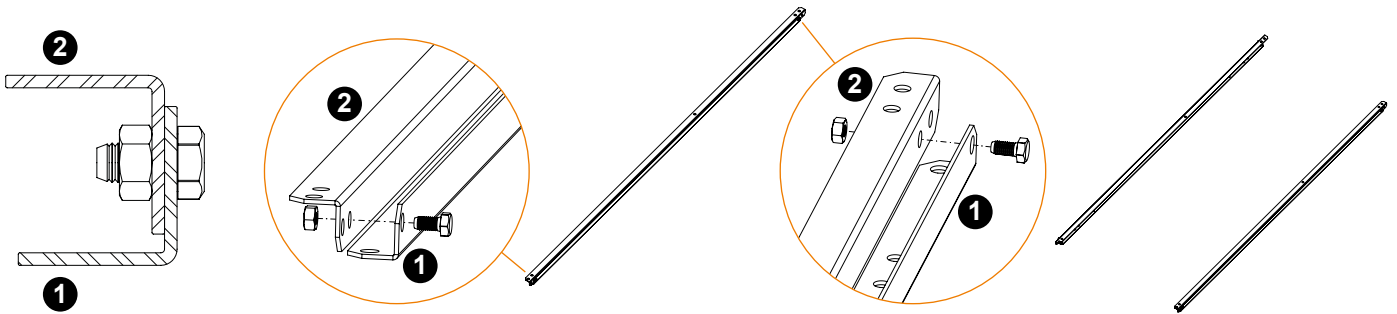

2. Place part 4 between the two Π shape parts constructed in the former step 1 in order for the frame to be formed. Screw straight parts 6 (which will be used for the mounting of the support base to the tiles) to the bottom part. Repeat for the rest of the parts.

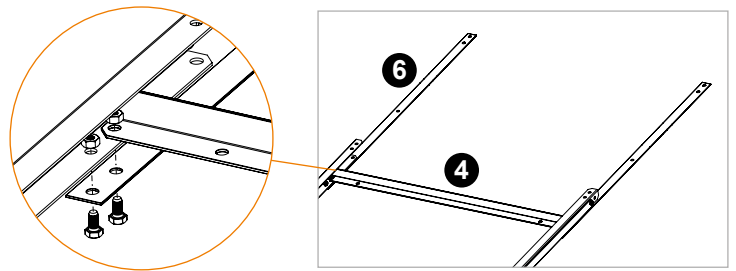

3. In case of two collectors model, place the collector supporting part 5 on bottom part and between the gaps of it we place the four collector's fixing washers 7 and tight the M8 screws with the nuts.

In case of one collector model you don't need to use part 5. The collector is going to be fixed with the 2 collectors' fixing washers 7 as it is described at the 3a balloon.

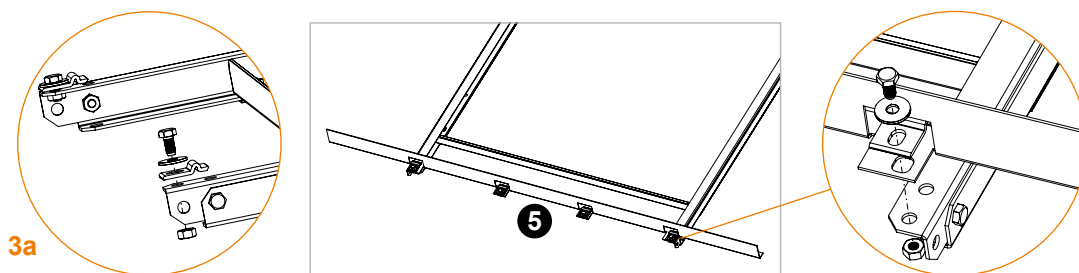

4. Repeat for the top part.

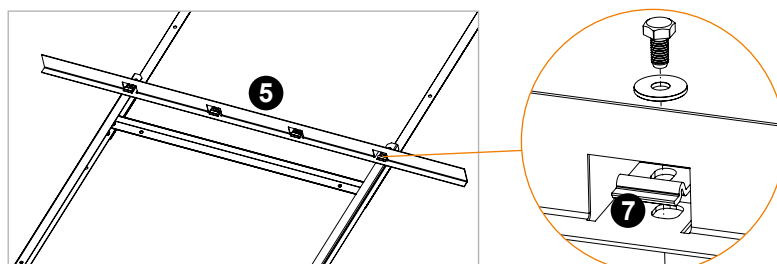

5. Bend the straight parts **6** of step 2 with the hand covering the beams of the tiled roof. Drill and fasten up with bolts. Use level so that the base is horizontally placed.

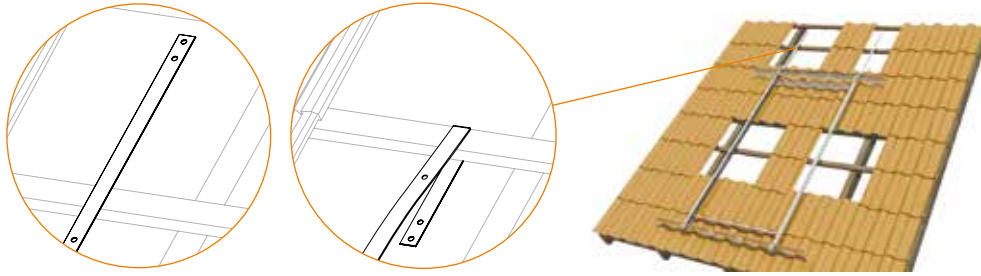

6. In case of two collectors, first place the left one, lifting the collector's upper and lower fixing washers **7**. When the collector is placed under, we slightly tighten the M8 screws and nuts with the collector's fixing washers **7** in order to temporarily restrain it and easily center it with the system. Place the mechanically tightened unions  $\text{Ø}22$  at the collector's edges.

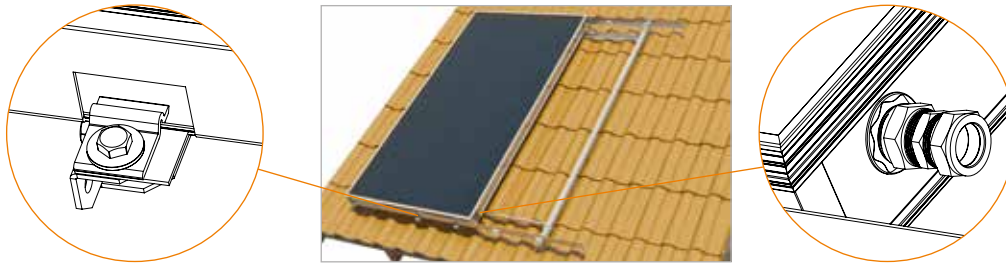

7. Join the second collector and tighten the union \*.
8. Place the T- piece with the air bleed and the sensor slot at the upper left part of the collector. Connect the pipeline to the inlet of the systems heat exchanger.
9. Place the  $\frac{3}{4}$ " x  $\text{Ø}22$  mechanically tightened plug at the collector bottom right edge for the connection of the boiler line\*. Connect the pipeline to the outlet of the systems heat exchanger.
10. Place and tighten the  $\text{Ø}22$  mechanically tightened plug on the top right and the bottom left of the collector/collectors.

*\*Use lock nuts in order to avoid the copper tube mechanical strain.*

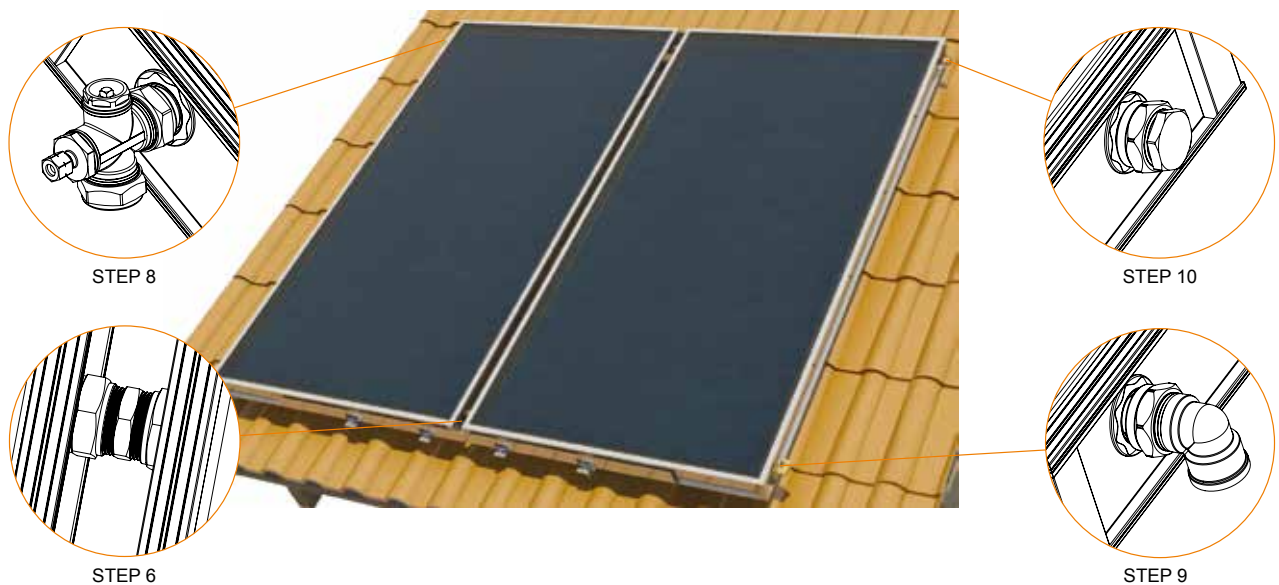

## POST INSTALLATION INSTRUCTIONS

Before using the system make a final check. Open all the valves and check for any kind of leakage. Repeat the inspection after 30 minutes. Check if the system is filled with water and antifreeze fluid according to the company's instructions. In case of any failure condition a specialized technician should be called in.

The solar water heater, in order to reach its highest efficiency rate, needs some hours (depending on the weather conditions and the solar radiation) after the completion of its installation. For this reason, even if the sun shines, it is highly recommended not to consume the hot water during the first hours following its installation.

A basic periodic maintenance will assure the long life and high efficiency of the solar water heater.

- It is recommended that the appliance is inspected in situ according to the instructions stated in the guarantee twice a year and checked for possible damage (breaking) of the collectors' glass, leaks in the connecting piping to the mains and to the consumption system, inspection of the pipe insulation and cleaning of the glass.
- If the collectors' glass is broken, it should be replaced immediately.
- It is recommended that the glass is washed at an hour of low sunlight to avoid damages due to expansion-contraction, due to temperature changes.
- If the fittings are worn (screws, pugs, piping, etc), these should be replaced at the owner's cost.
- The level of antifreeze in the closed circuit must be checked annually (as it could need topping up), to ensure the efficient operation.
- In cases where there is to be no use of hot water for long periods of time (e.g. during the summer holidays), it is recommended that the collector surface is covered with an opaque cover in order to avoid the building up of high temperatures, which could trip the thermoelectric fuse of the thermostat and cut the electrical circuit.
- During the build-up of high pressure in the thermal tank, it is possible that the safety valve will open and water will run out. This is a normal function that protects the water storage tank from high pressures. It's necessary to add a pressure reducer, safety valve and expansion tank to the mains pipeline.
- Do not switch on the electrical heating element in the following cases:
  - A) When the mains water supply has been cut
  - B) When the connecting pipes have frozen and there is no water flow from the water storage tank to the taps.

**ATTENTION!** Place taps with thermostatic regulation up to 38°C for hot water use to prevent burns which may be caused by the high temperature water in the solar water heater.

# CHECK LIST

## INSTRUCTIONS FOR THE INSTALLER

After the installation is complete, the installer, with the help of the check list below has to check all of the points which are noted and mark in the relevant column with a ✓.

LIST	CHECK
<b>COLLECTORS AND EXTERNAL PIPING</b>	
Is the installation and the fixing of the support base according to the instructions and local regulations?	
Is there an ideal location and facing of the collectors?	
Is there humidity inside the collectors?	
Are the hydraulic connections of the collectors correct?	
Has there been good UV protection on the thermal insulation?	
Is the piping properly insulated?	
Has the installment on the roof been done according to the local regulations?	
<b>HYDRAULIC CONNECTIONS</b>	
Are there any leaks in the closed circuit, the connections, or in the tube heat exchanger ?	
Are the safety valves installed properly?	
Does a mixing valve of hot / cold water exist?	
<b>ELECTRICAL CONNECTION</b>	
Is the electric resistance connected properly? (if it exists)	
Has the electric connection been done according to the local regulations? (insulation, grounding, etc...)	
<b>GENERAL</b>	
Was the guarantee properly filled in and given to the client?	
Were the instructions of use given to the client?	
Was the proper selection of the model made according to the needs of the client?	
Was the client informed of other options for the production of hot water?	

### Installer Data

Full name.....  
 Address.....  
 Telephone.....

### Distributor Data

Full name.....  
 Address.....  
 Telephone.....







